

SOLUTIONS FOR ENERGY EFFICIENCY IN BUILDINGS



THE GLOBAL SPECIALIST
IN ELECTRICAL AND DIGITAL BUILDING INFRASTRUCTURES

 **legrand**[®]



Legrand – a capable and reliable partner always at your disposal – is available to collaborate with you to help you find the **best systems solution for energy efficiency** to apply to the design of your systems.

Choosing Legrand, the world **specialist in electrical and digital infrastructures for buildings**, means a guarantee of optimum performance and long-term advantages.

Contents

1

Introduction and qualification of Legrand Group
page 7-15

2

Legislation and standardization
page 17-21

3

Energy Efficiency Demonstrator
page 23-27

4

Energy check
page 29-35

5

Offer overview
page 37-135

6

Building Energy Management System
page 137-141

7

Typical application examples
page 143-159

8

Reference projects
page 161-179

Legrand and the **sustainable development**

The Legrand group has been committed for many years, with its customers and partners, to developing a continuous improvement process and guaranteeing the responsible, profitable and long-term growth of its business.

For this reason the Group intends to provide a response to the environmental, economic and social problems of the present and the future.

- **A global approach for sustainable development**

Legrand's approach to sustainable development is oriented towards three areas: social responsibility, the environment and governance.

For more information visit www.legrand.com

- **Reduction of the environmental impact of the group sites**

Since 1996 Legrand has integrated environmental protection and management in the operations by which it manages its industrial sites.

- **Control of the use of chemical substances**

In producing its products the Legrand Group systematically looks for technical solutions which can replace the use of dangerous products.

- **Ecological products**

Legrand puts an eco-design approach into effect to limit the global impact which the products have on the environment during their life cycle.

COMPANY SOCIAL RESPONSIBILITY

Voluntary initiatives such as signing the Global Compact or respecting the rigid social and environmental criteria laid down by the FTSE4Good and DJSI Indices form part of a general policy aimed at transparency, to highlight Legrand's concrete commitment to the Company Social Responsibility framework



WE SUPPORT



A Certified Group

The Legrand Group has obtained in 2016 the ISO 50001 certification for the Energy Management System. This certification covers the Legrand head office, the 21 production sites and the logistic sites in Europe.



The Legrand +

Legrand is the first French industrial group to obtain ISO 50001 multi-site certification on a large European perimeter.



An eco-responsible group

The Group brands offer PEP Ecopassport® (environment profiles and products conforming to ISO 14025) for most of their products.



1

Introduction and qualification of Legrand Group

- Legrand, a global player
- Legrand Energy Efficiency Strategy
- Business areas
- General offer perimeter

Legrand, a global player

Legrand is the global specialist in electrical and digital building infrastructures.

The Group offers a comprehensive range of solutions and services tailored to residential, commercial and industrial markets.

The scope of its offering and its leading positions make Legrand a worldwide benchmark.

3 MARKETS



Residential



Commercial



Industrial

AN ACTIVE INTERNATIONAL PRESENCE

ESTABLISHED IN OVER **80 COUNTRIES**

OVER **36,000** EMPLOYEES IN 2016

SALES IN CLOSE TO **180 COUNTRIES**

CONTINUOUS INNOVATION

4% TO 5% OF SALES DEDICATED TO R&D EVERY YEAR



Integration of NFC* technology into Legrand products is just one example of ongoing development.

*Near Field Communication



LEADING POSITIONS

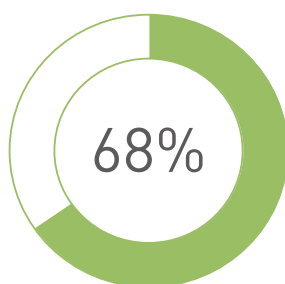

of sales are from products that rank first or second in their respective markets (2014).

World leader in the interface for control and connection and in cable management products.



Legrand Energy Efficiency Strategy

Answering to our customers' needs in terms of comfort, security and productivity while using less energy.

APPLICATIONS

Free Cooling

Home Automation

Renewable Energies

Monitoring and Reporting

Active Energy Management

Digital Lighting Management

Electrical Vehicle Charging Station

Measurement and Supervision

Efficient Energy Distribution

Guest Room Management

HVAC / Heating control

Power Quality

VERTICALS

Hotels

Industry

Education

Warehouses

Commercial Stores

Data Centers

Residential

Hospitals

Offices

CLIENTS

Specifiers



System Integrators



Electrical Contractors



Facility Managers



Investors



Our business...

From control and connection interfaces to cable management, energy distribution and voice-data-image (VDI) distribution systems, Legrand provides a host of solutions designed to manage lighting, energy, networks and building access.

A PORTFOLIO OF **FLAGSHIP BRANDS**

Legrand • BTicino • Adlec • Arnould
• Cablofil • C2G • HDL • HPM • Indo
Asian Switchgear • Inform • Lastar
• Middle Atlantic • Minkels • Neat •
Numeric UPS • On-Q • Ortronics • Pass
& Seymour • Raritan • Seico • Shidean
• SMS • Vantage • Watt Stopper •
Wiremold • Zucchini and more

The Legrand group has
more than **50 BRANDS**

A WIDE CHOICE BY ANY MEASURE

OVER **230,000**
CATALOGUE
ITEMS

MORE THAN
80 PRODUCT
FAMILIES



3 Key business areas



EFFICIENT ENERGY
DISTRIBUTION



ENERGY EFFICIENT
DATA CENTER



ACTIVE ENERGY
MANAGEMENT



General offer perimeter



EFFICIENT ENERGY DISTRIBUTION



Green Transformer

page 39



Green Busbar

page 42



Power quality and power factor correction

page 45-47



UPS

page 50

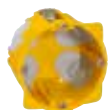

EcoBatibox™

page 55



EFFICIENT ENERGY DATA CENTER



Cold corridor

page 59



Air conditioning

page 63



Metering with smart PDU

page 66



ACTIVE ENERGY MANAGEMENT



Energy Management:
Measure, report, status,
command & visualize data
on site or remotely

page 75



Measure of the
energy integrated to
Power devices or with
measuring central units

page 76



Energy Management
System

page 80



Building Management
System

page 88



Load shedding
equipment

page 90



Lighting management &
Lighting Control

page 92



A new management of
the lighting

page 106



HVAC control

page 121



Solar panel connection

page 126



Electrical vehicle
charging station

page 131



2

Legislation and standardization

- The view of UE
- Legislation
- Standardization
- Classification schemes

Energy Efficiency

The view of UE

The energy strategy fixed by UE to be reached by the year 2020 is based on:

**-20% ENERGY
CONSUMPTION**

**>20%
RENEWABLE
SOURCES**

**-20%
GREENHOUSE
EMISSION**

**For further details, consult the EU webpage
about 2020 energy strategy:**

[http://ec.europa.eu/energy/en/topics/
energy-strategy/2020-energy-strategy](http://ec.europa.eu/energy/en/topics/energy-strategy/2020-energy-strategy)

The UE creates a legislative framework
based on this principle.



Energy Efficiency Legislation

The basic implementing tools for the EU energy strategies are the Directives.

- **Energy Efficiency (EE) directive**
- **Energy Performances of Building Directive (EPBD)**
- **EcoDesign Directive**

All EU countries shall align their legislation to these three fundamental directives.

The EU directives are under constant revision process.

See the latest at: <http://ec.europa.eu/energy/en>

As a consequence to the Directives, specific regulations have been published and technical standardization mandates have been submitted to European Standard Organizations (CEN, Cenelec and ETSI) in order to fix energy efficiency requirements in all the relevant areas, including transports systems, urban planning and the corresponding tools to verify the such a compliance. Financial support to implement energy efficiency measures are under constant development in each Country.

For the latest in legislation, please consult the appropriate webpages:

- **EE Directive national action plans:**
<http://ec.europa.eu/energy/en/topics/energy-efficiency/energy-efficiency-directive/national-energy-efficiency-action-plans>
- **EPBD Directive implementing measures:**
<http://ec.europa.eu/energy/en/topics/energy-efficiency/buildings>
- **Eco-design Directive related regulations:**
http://ec.europa.eu/growth/industry/sustainability/ecodesign/index_en.htm

The design of energy demanding products buildings as a comprehensive entity processing energy, including installations is part of this scenario.

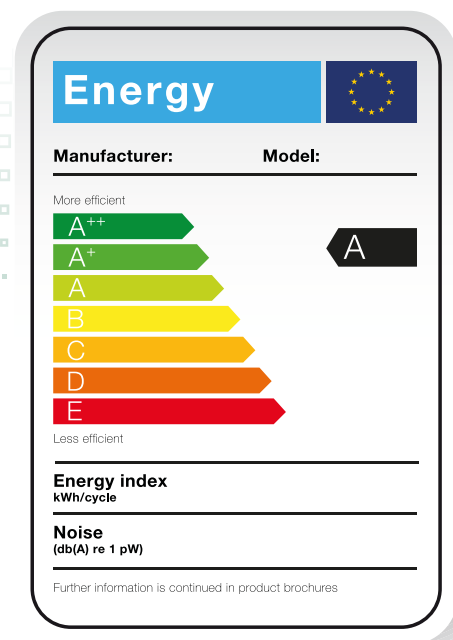

Energy Efficiency Standardization

Energy efficiency impact standardization of electrical installations and equipment:

- **IEC 60364-8-1**
Low voltage electrical installations
Part 8-1: Energy efficiency
- **EN 15232**
Energy performance of buildings
Part 1: Impact of Building Automation,
Controls and Building Management
- **IEC 60947-1**
Low voltage switchgear and controlgear
Part 1: General rules / Annex V / Power
management with switchgear and
controlgear for energy efficiency
- **Future EN 15193-1**
Energy performance of buildings /
Energy requirements for lighting
Part 1: specifications
- **Standard IEC 60076-20**
Energy efficiency practices for power
transformers. Refer more specifically to
standards EN 60076-1 to 60776-5 and
EN 60076-11 version 2004 (for dry-type
power transformers)



A number of standardization projects is under progress in order to cover more and more electrical equipment with specific energy efficiency requirements.

These projects include:

- LSE, Load Shedding Equipment
- SSE, Source switching equipment
- “Pro-sumers” (Producers – Consumers) low voltage electrical installations.

Energy performances Classification schemes

A number of energy performances classification schemes for buildings have been created. This approach allows to identify the environmental sustainability of the buildings. Sustainability includes energy efficiency.

The most popular schemes are:



LEED

Leadership in Environmental and Energy Design

www.usgbc.org/leed



BREEAM

Building Research Establishment Environmental Assessment Method

www.breeam.com



HQE

Haute Qualité Environnementale

www.behqe.com/home

The building classification schemes have a comprehensive approach to cover:

- Location and transportation
- Sustainable site
- Water efficiency
- Energy and Atmosphere
- Material choice
- Environmental Quality
- Innovation
- Regional priorities
- Wastes.

Energy is a fundamental part of the building classification scheme and it's highly affected by the installation design and the equipment choice.



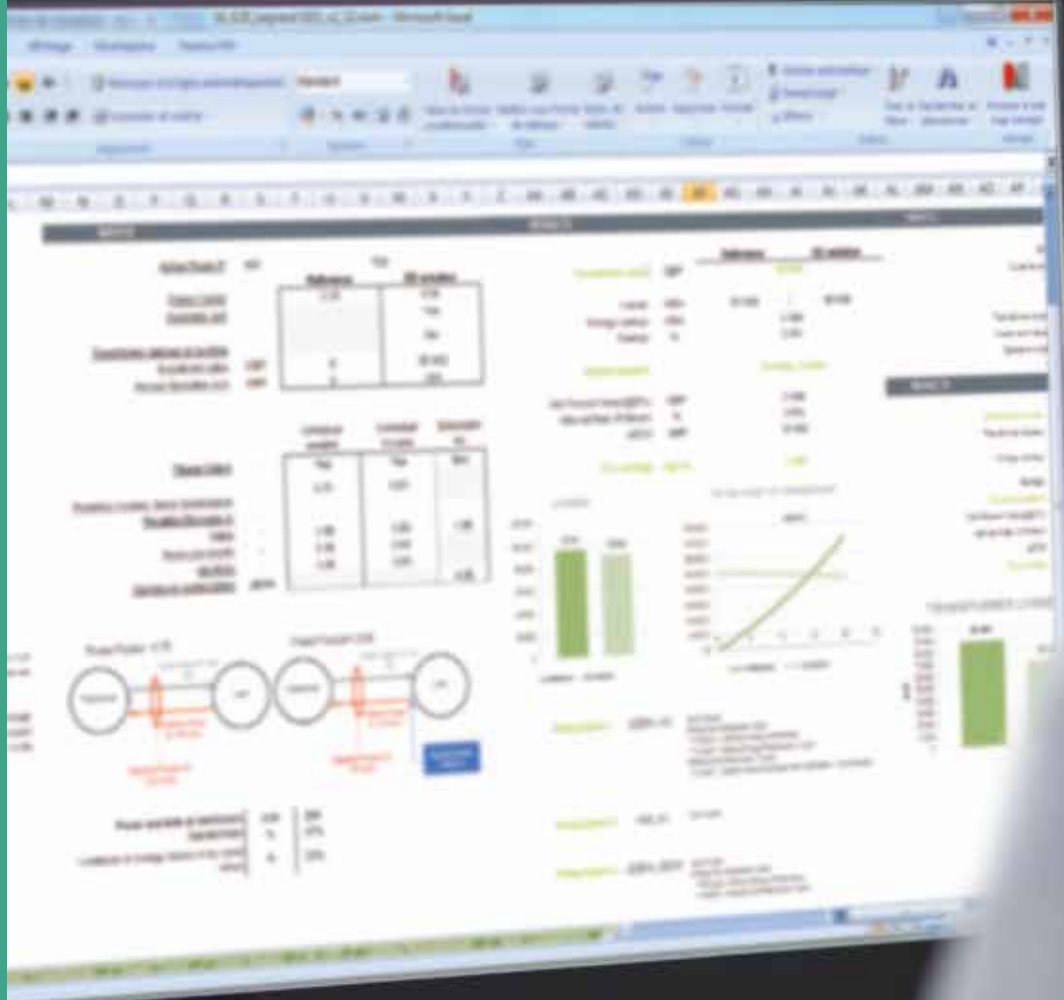

3

Energy Efficiency Demonstrator

- Information about demonstrator
- Features
- Where can I find and how can I request the demonstrator?

Information about demonstrator

FEATURES & BENEFITS

EE Demonstrator is a tool that estimates the energy saving potential for all Legrand Energy Efficiency solutions. Calculations are based on rules specified in standards.

For each solution:

- it determines the energy saving level in local currency and kWh
- it estimates the simple payback
- it calculates the project economic data (NPV, IRR and Savings on TCO)
- it gives the scoring for Environmental Rating Systems (LEED BREEAM or HQE)

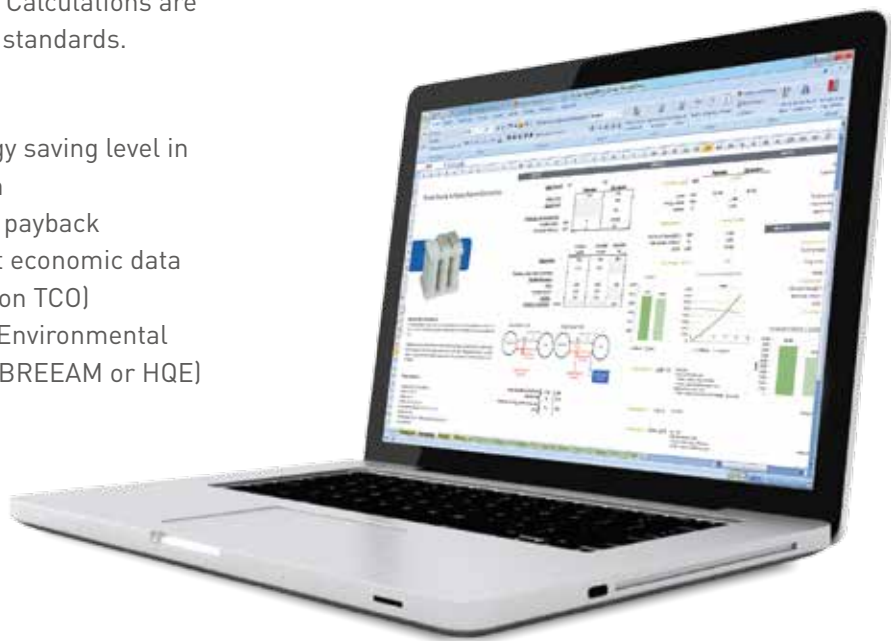

GLOBAL RESULTS

EE Demonstrator presents a dashboard of consolidated results for the complete building project.

Comparing investments, savings and payback, it helps you in your decision process for your project.

→ Information about demonstrator

Energy Efficient Applications are introduced in 3 sections

a) Presentation

b) Inputs

c) Results

PRESENTATION

First section gives marketing key notions and outlines major characteristics.

INPUTS

Second section collects EE application specific data needed for the calculation.

RESULTS

Calculation algorithms are based on international Energy Efficiency standards rules.

The last section presents the results of the calculations:

- energy savings (in local currency and kWh)
- simple payback period
- financial information (NPV, IRR and savings on TCO)
- savings on CO2 emission

and environmental rating systems scoring LEED, BREEAM and HQE are covered.

Features

FEATURES & BENEFITS

The demonstrator gives the possibility of:

- assign a series of items of information to each project
- save and file the projects
- recall and modify the projects already carried out
- print them to attach them to the project documentation

Your Contact	
Surname	Bernard
First Name	Laurence
e-Mail	bernard.laurence@legrand.fr
Phone	+33 4 38 14 71 93
Mobile	+33 7 25 96 83 37
Direction Régionale - Ile de France BP 37, 82 rue Robespierre 93170 Bagnolet France ☎ : 01 49 72 82 00 Fax : 01 49 72 92 38 ✉ fr-di-peris@legrand.fr	
Activity code	Project setting

Example: compilation of the sales person data

Client	
Company Name	HISCOX ARCHITECTS
Address 1	2 Pancras Village
Address 2	-
Town	King Cross
Postcode	WC1
Country	United Kingdom
Contact Details	
Surname	Nicolas
First Name	Nicolas
Job Title	Architect
e-Mail	nicolas.hiscox@harch.co.uk
Phone	-
Mobile	+44 7 53 20 71 33
Address 1	2 Pancras Village
Address 2	-
Town	King Cross
Postcode	WC1
Country	United Kingdom
General Parameters	
Language	English
Select Currency	GBP
Electricity rate	GBP/kWh 0,120
Inflation Rate of Electricity	% 2,0%
Inflation Rate	% 2,0%
Expeded Internal Rate Of Return	% 5,0%
kgCO ₂ /kWh*	- 0,457

Example: compilation of the customer's data and general parameters

ENERGY EFFICIENCY APPLICATIONS	
Efficient Energy Distribution	
Yes	Green Transformer
Yes	Green Busbar
Yes	Power Quality & Power Factor Correction
No	HE UPS
No	Eco Wallbox
Active Energy Management	
Yes	Metering & Display
Yes	Building Energy Management System (BEMS)
No	Home Energy Management System
No	Load Shedding Equipment
No	Active Lighting Fixtures
No	HVAC Control
No	Time Switch / Green Socket
Yes	Lighting Management
No	Storage Management
Yes	EV Charging Station
EE Data Centers	
No	Air Conditioning
No	Rack Containment
No	Metering with Smart PDU

Example: compilation of the applications used in the specific project

PROJECT DETAILS	
Project Name	Points Ixela
Building Type	Commercial
Address 1	84pt St
Address 2	-
Town	Leeds
Postcode	-
Country	United Kingdom
Yearly Electrical Consumption	kWh 33 000
Building Leaseable Area	m ² 4 000
Rating System 1	LEEDV4_NC
Rating System 2	LEEDV4_EBOM
Rating System 3	HQE_NC

Example: compilation of the project details

Where can I find and how can I request the demonstrator?



The demonstrator is a piece of software which must be requested from the Legrand agency staff by filling in the “Request form” available on the web site. You will then be contacted directly by one of our sales staff.

For more information please visit the dedicated page on <http://elene-program.legrand.com/>



4

Energy check

- Energy efficiency audit
- Products and tools

Energy efficiency audit

Needing advice, looking for solutions to optimize energy costs and make savings ... Our services answer all your needs. Our experts support you in your projects.

LEVEL 1 - ACCESS AUDIT

Conditions of premises and energy potential

On-site surveys and visits

Collection of data on the following elements:

- the building, the opaque and windowed walls, air permeability, solar protection,...
- the heating , ventilation, air conditioning and lighting systems
- the surfaces and activities in the rooms.

Conditions of premises and systems

- Producing a photographic report with attached descriptions and comments
- Identification of the building's weak points

Analysis of the energy and water bills

This analysis allows:

- the adjustment of the energy supply contracts subscribed
- a positioning of the building on the scale of EPD (Energy Performance Diagnosis) energy and greenhouse effect classes

Delivery of documents

A complete energy audit report will be released at the end of our task. Legrand proposes actions to improve the building's energy classified by time of return on investment. For each improvement proposal, an estimate of the investment and the energy/ financial/environmental savings will be made with a description of the products and their installation.

RELEASE OF A PRICE PROPOSAL WITHIN 72 HOURS

The Pro Relations Service will evaluate the time needed to carry out the study.



LEVEL 2 - MEDIUM AUDIT

Regulatory energy modelling and proposal of programmes of work

As well as the services described for level 1, level 2 includes:

Kick-off meeting

- to define the objectives to be reached and describe the method applied
- to collect the documents for the task
- to establish the task plan
- to organize the building inspection

Initial energy balance according to the Th-C-E ex method

The initial energy consumptions will be estimated according to the regulatory calculation methods.

Proposal of energy improvement actions

The following will be produced for each proposal:

- a detailed description of the products and their installation and a theoretical balance
- a balance of the energy and cost savings
- an estimate of the investment
- a calculation of the return on investment
- an evaluation of the quantity of capitalisable kWh CUMAC if the CEE system allows it

Meeting to present the energy audit

A meeting with delivery of the final report will be organized to present the conclusions of the energy audit.

Legrand will produce 2 programmes of improvement works which will include a technical and cost description.

A thermal modelling of the buildings will be made to guarantee the conformity of the works.

Delivery of documents

Level 2 includes all the documents indicated for level 1, to which is added the improvement action summary table which includes the 2 programmes of work which present the most profitable and priority solutions.

RELEASE OF A PRICE PROPOSAL WITHIN 72 HOURS

The Pro Relations Service will evaluate the time needed to carry out the study.



LEVEL 3 - PREMIUM AUDIT

Advanced energy modelling and support to the programmes of work

As well as the services described for level 2, level 3 includes:

Initial energy balance according to the STD method

The initial energy balance will be made by modelling the building using thermodynamic simulation software. This powerful calculation tool can take account not only of the real operation parameters of the building but also of its external environment.

The thermal modelling of the building before and after the works will ensure that the programmes of work proposed conform to the thermal regulations in force.

Intermediate meeting to identify programmes of work

In this intermediate meeting you will be shown the balance of the initial status of the first results of the energy audit. The main object will be to define 3 programmes of work (group of combined works) which allow reaching the objectives fixed to obtain a reduction of the building's energy consumptions.

Delivery of documents

Level 3 includes all the documents indicated for level 2, to which is added the improvement action summary table which includes the 3 programmes of work which present the most profitable and priority solutions.

RELEASE OF A PRICE PROPOSAL WITHIN 72 HOURS

The Pro Relations Service will evaluate the time needed to carry out the study.



→ Energy efficiency audit

Services & studies

PERFORMANCE	LEVEL 1 ACCESS	LEVEL 2 MEDIUM	LEVEL 3 PREMIUM
CONDITIONS OF PREMISES AND ANALYSIS			
Kick-off meeting		●	●
On-site surveys and visits	●	●	●
Conditions of premises and systems	●	●	●
Analysis of the energy and water bills	●	●	●
Energy classes according to the EPD classification on the basis of bills	●	●	●
DIAGNOSTIC			
Initial energy balance according to the Th-C-E ex method		●	●
Initial energy balance according to the STD method			●
Comparison of the results with the real energy bills		●	●
RECOMMENDATIONS AND WORK SIMULATIONS			
Simplified proposal of energy improvement actions	●		
Proposal of energy improvement actions in card form		●	●
Summary of the improvement actions	●	●	●
Intermediate meeting to identify programmes of work			●
Estimate of the cost of the energy saving Certificates		●	●
Modelling of 2 programmes of work		●	
Modelling of 3 programmes of work			●
Regulatory check of the programmes of work		●	●
DELIVERY OF THE STUDY			
Energy audit presentation meeting		●	●
Energy audit report	●	●	●

→ Products and tools

INTELLIMETER® Pro Logger



FEATURES & BENEFITS

The Intellimeter Pro (IT-200) is a revolutionary occupancy and light logger that establishes the energy saving potential when using occupancy sensors. With this versatile tool, spaces for lightning control use can be pinpointed and saving can be verified.

- Determines energy savings potential from occupancy sensors use
- Adjustable light pipe observes lighting level
- Logs when a space is occupied/vacant and when lighting is on/off
- IT-ProSoft Software provides single-step data retrieval, storage, analysis and printing
- Lithium battery with average life of 10 years
- Small and lightweight for ease of use and portability

LIGHTING/OCCUPANCY SUMMARY

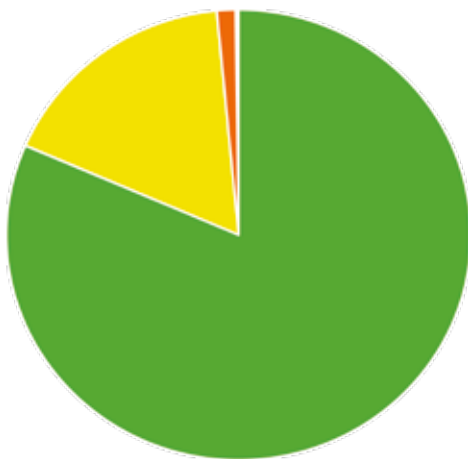

■ On+Occupied
117,2 hours
81.5%

■ On+Vacant
24,50 hours
17.0%

■ Off+Occupied
1,83 hours
1.3%

■ Off+Vacant
0,32 hours
0.2%

LIGHTING STATISTICS

- Total On time: **141,72 hours**
- Average On period: **0,99 hours**
- Shortest On period: **0,02 hours**
- Longest On period: **51,85 hours**
- Total On/Off cycles: **104**
- On/Off cycles per day: **17.3**

OCCUPANCY STATISTICS

- Total Occupancy time: **119,05 hours**
- Average Occupancy period: **0,40 hours**
- Shortest Occupancy period: **0,08 hours**
- Longest Occupancy period: **4,98 hours**
- Total Occupancy cycles: **297**
- Occupancy cycles per day: **49.5**

→ Products and tools

Lanalyseur Alptec 2333b

Would you like to have a quality analysis of your network to improve energy performance?
Are you faced with a specific problem which requires a dedicated answer?



THE WINNING MANAGEMENT OF YOUR ELECTRICITY NETWORK

The “Energy quality” audit identifies the weak points of the network, dimensions the compensation of reactive energy and supports you in the choice of optimized solutions for the energy supply.

The **Alptec 2333b** portable analyser records the important electrical phenomena of your installation, on the secondary TGBT network (from 230 to 700 V) or via the measurement transformers (for the HV 6 kV, 20 kV and 63 kV) networks.

The following will be recorded systematically to propose the best optimisation solutions:

- voltages and currents
- current and voltage harmonics, apparent powers
- active and reactive
- the phase displacements
- the voltage drops and overvoltages as well as the associated wave shapes



5

Offer overview

- Efficient Energy Distribution
- Efficient Energy Data Center
- Active Energy Management



Efficient Energy Distribution



Green Transformer

[page 39](#)



Green Busbar

[page 42](#)



Power quality and power factor correction

[page 45-47](#)



UPS

[page 50](#)

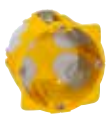

EcoBatibox™

[page 55](#)

→ Efficient Energy Distribution

Green T.HE cast resin transformers



With the entry into force in July 2015 of the new European Commission **regulation (548/2014)** for eco-compatible design, the efficiency standards required for transformers have become stricter. This means guaranteeing a considerable reduction in energy consumption, favouring a considerable cost saving and reducing CO₂ emissions to the atmosphere.

The **Legrand Green T.HE** transformers, complying to standard **EN 50588-1**, are designed and manufactured in conformity with European Community regulation 548/2014 (see slide 2), laying down the modes of application of the Directive on eco-compatible design 2009/125/CE.

REFERENCE STANDARDS

Standard EN 50588-1 applies to three-phase transformers with powers between 5 kVA and 40 MVA supplied with frequency 50 HZ and with maximum voltage per component (U_m) greater than 1.1 kV but not greater than 36 kV.

Regulation 584/2014 lays down the obligatory requirements in the countries of the European Union (28 nations) for the eco-compatible design of electric transformers with powers greater than 1 kVA, used in electrical energy transmission and distribution networks.

CLASSIFICATION

A resin transformer is classified on the basis of the value of the characteristic **no-load (P_0)** and **load (P_k)** losses of the machine itself.

More precisely, **P_0** losses are independent of the loads and remain constant for the whole time the transformer is connected to the electrical mains. **P_k** losses on the other hand only occur when a load is connected to the transformer and vary quadratically with the load itself.



NO-LOAD LOSSES (P_0)	LOAD LOSSES (P_k)
A_0	A_k
A_0	B_k

ECOCOMPATIBLE DESIGN REQUIREMENTS OF NEW REGULATION 548/2014

Rated power (kVA)	PHASE 1 (FROM THE 1st JULY 2015)		PHASE 2 (FROM THE 1st JULY 2021)	
	Maximum load losses P_k (W)	Maximum no-load losses P_0 (W)	Maximum load losses P_k (W)	Maximum no-load losses P_0 (W)
≤ 50	B_k (1700)	A_0 (200)	A_k (1500)	A_0 -10% (180)
100	B_k (2050)	A_0 (280)	A_k (1800)	A_0 -10% (252)
160	B_k (2900)	A_0 (400)	A_k (2600)	A_0 -10% (360)
250	B_k (3800)	A_0 (520)	A_k (3400)	A_0 -10% (448)
400	B_k (5500)	A_0 (750)	A_k (4500)	A_0 -10% (675)
630	B_k (7600)	A_0 (1100)	A_k (7100)	A_0 -10% (990)
800	A_k (8000)	A_0 (1300)	A_k (8000)	A_0 -10% (1170)
1000	A_k (9000)	A_0 (1550)	A_k (9000)	A_0 -10% (1395)
1250	A_k (11000)	A_0 (1800)	A_k (11000)	A_0 -10% (1620)
1600	A_k (13000)	A_0 (2200)	A_k (13000)	A_0 -10% (1980)
2000	A_k (16000)	A_0 (2600)	A_k (16000)	A_0 -10% (2340)
2500	A_k (19000)	A_0 (3100)	A_k (19000)	A_0 -10% (2790)
3150	A_k (22000)	A_0 (3800)	A_k (22000)	A_0 -10% (3420)

Requirements applicable (loss values) to medium-sized three-phase transformers with rated power ≤ 3150 kVA dry type, with one winding with U_m ≤ 24 kV and the other with U_m ≤ 1.1 kV

The purchase price of a transformer represents only a marginal part of the total machine cost (TCO), while the operating cost (linked mainly to the losses) represents more than 80% of the total cost. Purchasing a transformer designed according to eco-compatible rules means gaining both a cost and an environmental advantage.

To summarize:

$$\text{Total cost of the CRT} = \text{Purchase cost (20\% effect)} + \text{Operating cost (80\% effect)}$$

EXAMPLE OF A COST CALCULATION OBTAINED USING A HIGH-EFFICIENCY GREEN TRANSFORMER

EUROPE

Rated power (SR): 1000 kVA

Primary no-load voltage (V10): 20 kV

Secondary no-load voltage (V20): 400 V

Uk: 6%

Transformer lifetime: 20 years

In this example, the extra 4,500 € required for the purchase of the Green T.HE transformer is recovered in less than six years, while the total saving for the 20-year period will be approximately 8,500 €.

	Class N transformer	Class AA Green T.HE
Purchase price	14,000 €	18,500 €
Operating cost (20 years)	50,971 €	37,923 €
TOTAL Cost	64,971 €	56,423 €

FINANCIAL SAVING
8,548 €

SAVING IN TERMS OF CO2 EMISSIONS
112 Ton CO2



Note: the cost saving has been calculated taking the electricity tariffs shown on the site as reference EUROSTAT EU-28: cost of the electricity 0.1170 €/kWh. Equivalent 0.5778 kgCO2/kWh.

Class N transformer

Old CRT with high loss levels.

Green T.HE transformers

New transformers with low loss levels, respecting new regulation 548/2014.



→ Efficient Energy Distribution

Green Busbar



The busbar is the most modern solution for distributing medium-large powers, supplying light fittings in warehouses, fairs and any space where speed of assembly offers tangible benefits. The busbar is also frequently used to supply the backbones (horizontal and vertical) of service-sector buildings favouring respect of installation times and offering a final solution with many technical advantages.

The ZUCCHINI busbars, available in 3 distinct amperage ranges

(Low Power 25A-63A, Medium Power 63A-1000A and High Power 630A-6300A), can satisfy any installation requirement from **25 A to 6300 A.**

REFERENCE STANDARD

CEI EN 61439-6

Assembled protection and non-automatic equipment for low voltage (LV boards)

Part 6: Busbars. Date of publication 2013-07 (come into force definitively on 27-06-2015)

This Standard gives the definitions and establishes the operating conditions, manufacturing provisions, technical features and check provisions for busbar systems with rated voltage not greater than 1000 V a.c. or 1500 V d.c., intended for use in the field of the generation, transmission, distribution and conversion of electricity and the command and control of equipment using electricity.



CROSS-SECTION OF AN INTERNAL CONDUCTOR AND LOSSES BECAUSE OF THE JOULE EFFECT

The losses because of the Joule effect are due to the electrical resistance of the busbar. The energy lost is dissipated in heat and contributes to heating the duct and the room.

$$P_j \text{ (W/m)} = \frac{(3 \times R_t \times I_n^2) \times (I_b / I_n)^2}{1000}$$

$$P_j \text{ (W/m)} = \frac{(3 \times 0,03022 \times 2000^2) \times (1600/2000)^2}{1000} = 232.090 \text{ W/m}$$



Electricity Cost (€/per year)
Using a 2000 A AL busbar with 1292 mm² cross-section



$$\frac{(P_j \times L \times h/\text{year}) \times \text{Cost } \text{€}/\text{kWh}}{1000}$$

$$\frac{(232 \times 100 \times 8760) \times 0,17}{1000} = 34,563\text{€}/\text{year}$$



PJ JOULE EFFECT LOSSES			
Line length (metres)	100	Load factor (%) (lb/ln)	80%
Operating hours per year (h/year)	8760	Electricity Cost (€/kwh)	0.17
Pj (W/m)	232	😊	261
Electricity cost (€/kwh per year)	34,563	😊	38,886
Energy saving/year: 4,323 €			



SUMMARY

JOULE EFFECT LOSSES

LARGER busbar cross-section (mm²)

Rt (mΩ/m) LOWER phase resistance per unit of length of the busbar measured at thermal regime.

>
they are the LOSSES caused by the
JOULE EFFECT (W/m)

<
is SAVING in terms of price (€)

<
HEAT DISSIPATION in the room

>
the lifetime of the BUSBAR

DROP IN VOLTAGE

LARGER busbar cross-section (mm²)

Rt (mΩ/m) LOWER phase resistance per unit of length of the busbar measured at thermal regime.

X (mΩ/m) LOWER Phase reactance (50 Hz)

There will be a DROP IN VOLTAGE <
(this value is very important when dimensioning
the line in a system)

→ Efficient Energy Distribution

Power Quality

WHY A GOOD QUALITY OF THE ENERGY?

Just for the industrial sector, the cost of poor energy quality in the EU-25 amounts to **150 billion euros per year**



A GOOD QUALITY OF THE ENERGY ALLOWS TO:

Increase the power availability

- Take care of needs arising from network blackouts and compensate for damaging voltage drops in the industrial and service sectors
- Optimize the sizing of your system

Reduce maintenance costs for your electrical system

- Manage harmonics to avoid premature ageing of equipment and the destruction of sensitive components
- Reduce transformer noise and overheating

Improve the energy performance of the building

- Optimize energy consumption, reducing electricity bills, energy losses and CO2 emissions



Examples of equipment/devices to use in relation to the phenomena on the electricity network

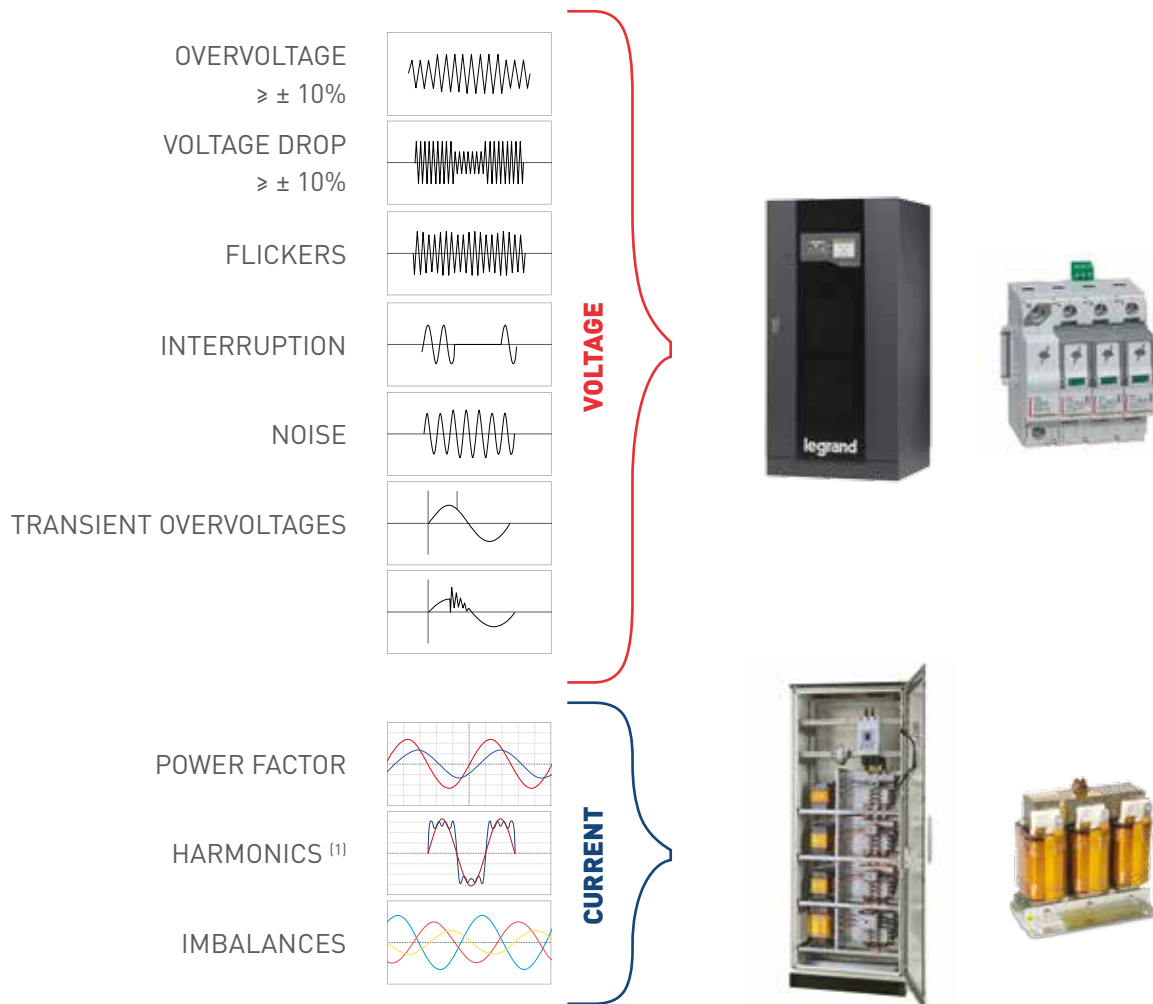

HARMONIC IMPACT ⁽¹⁾

- Premature ageing or destruction of capacitors
In the case of a network strongly contaminated by harmonics, the installation of a Self Anti-Harmonics (SAH) supplied in series with the capacitor, is the only effective protection
- Power factor reduction
- Phenomenon of electrical resonance
- Equipment overheating (motors, transformers)
- Untimely triggering of the protection circuit breakers
- Interference of electronic instruments (computer, PLC, etc.)

→ Efficient Energy Distribution

Power Factor Correction



An alternating current electrical system, including loads such as transformers, motors, fluorescent tube ballasts or any other load whose intensity is out of phase with respect to the voltage, consumes reactive energy. Energy suppliers bill this reactive energy (expressed in kilovar/hour – kVArh) at the same rate as active energy. Reactive power thus leads to a greater consumption of power and increases the electricity bill.

POWER FACTOR

By definition the power factor of an electrical system (PF) is equal to the ratio of the active power P (kW) / apparent power S (kVA).

$$\text{Power Factor (FP)} = \frac{\text{Active Power P (kW)}}{\text{Apparent Power S (kVA)}}$$

A good power factor is:

- $\cos \varphi$ high (near 1)
- or $\text{tg } \varphi$ low (near 0)

$\cos \varphi$ and $\text{tg } \varphi$ are joined by the following relation:

$$\cos \varphi = \frac{1}{\sqrt{1 + (\text{tg } \varphi)^2}}$$

A power factor of 1 does not consume any reactive energy and viceversa.

Energy meters record the consumptions of active and reactive energy. Normally electricity suppliers use the term $\text{tg } \varphi$ in their bill.

POWER DIAGRAM

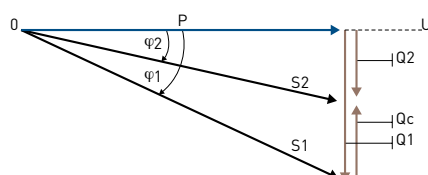

P: active power
 S1 and S2: apparent powers
 Qc: reactive power of the capacitor
 Qc: reactive power without capacitor
 Qc: reactive power with capacitor

RELATIONS

$$Q_2 = Q_1 - Q_c$$

$$Q_c = Q_1 - Q_2$$

$$Q_c = P \cdot \text{tg } \varphi_1 - P \cdot \text{tg } \varphi_2$$

$$Q_c = P(\text{tg } \varphi_1 - \text{tg } \varphi_2)$$

φ_1
 phase displacement without capacitor
 φ_2
 phase displacement with capacitor



ADVANTAGES

By supplying reactive energy on demand, the Alpes Technologies capacitor banks offer the user the following advantages:

1) Increase of the power available in the power transformers

EXAMPLE

For a 1000 kVA transformer with $\cos \varphi = 0.75$ and a 750 kW installation: by improving the $\cos \varphi$ to 0.96 one may gain an extra 210 kW (+28%).

Power factor level $\cos \varphi$	Extra power available in the transformer
-----------------------------------	--

0.8	+7%
0.85	+13%
0.9	+20%
0.96	+28%
1	+33%

2) Limitation of the energy losses in the wires due to the Joule effect

considering the reduction of the power transported in the installation (limitation of the voltage drops).

EXAMPLE

For a 1000 kVA transformer with $\cos \varphi = 0.75$ and a 750 kW installation: by improving the $\cos \varphi$ to 0.96 one obtains a current reduction of about 22%.

3) Energy saving, whatever the type of electricity supplier contract

The installation of a capacitor bank means:

- obtaining energy savings
- avoiding the penalties applied by the electricity supplier
- optimising the electricity contract

OPERATING PRINCIPLE

Capacitor banks can improve the power factor of an electrical system, supplying it with part of the reactive energy it consumes.

The capacitor is a load made up of two conducting parts (electrodes) separated by insulation. This load has the property, when it is subjected to a sinusoidal voltage, of dephasing its intensity, thus its power (reactive capacitive), by 90° forwards with respect to the voltage.

On the other hand, all the other loads (motor, transformer, etc.) dephase their reactive component (intensity or reactive inductive power) by 90° backwards with respect to the voltage. The vectorial composition of these intensities or reactive powers (inductive and capacitive) leads to a resulting intensity or reactive power less than that existing before the installation of capacitors.

To simplify, one may say that the inductive loads (motor, transformer, etc...) consume reactive energy while the capacitors (capacitive loads) produce reactive energy.



$\cos \varphi \approx 0.7$ ($\text{tg } \varphi \approx 1.02$)

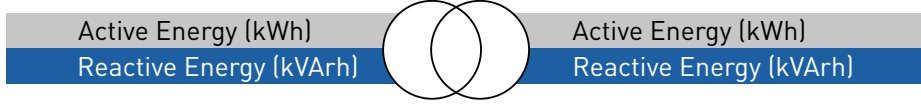

$\cos \varphi \approx 1$ ($\text{tg } \varphi \approx 0$)

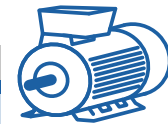
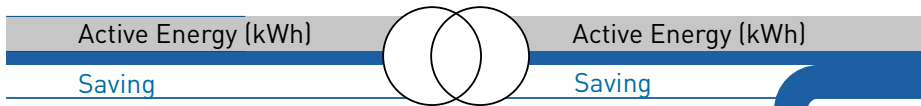

ELECTRICAL
MAINS

LEGRAND GROUP OFFER - HV AND LV

Turnkey compensation cabinets



- 1 - Alplibloc fixed capacitor banks with incorporated circuit breaker
- 2 - Alpimatic automatic capacitor banks
- 3 - Alpimatic automatic capacitor banks with self anti-harmonics
- 4 - High-voltage capacitor banks

→ Efficient Energy Distribution

UPS "Uninterruptible Power Supply"



PROTECTION OF THE HIGH ENERGY EFFICIENCY SYSTEMS

UPS systems condition the power and store the energy for the critical mission structures (data centers, transmission centres and hospitals) and protect them against fluctuations of voltage or frequency.

They also supply autonomy or a temporary power supply to deal with any blackouts.

A UPS requires energy to provide these functions. The efficiency of a UPS is measured as output power divided by input power, with the UPS which consumes part of this power (self-consumption).

The amount of energy consumed by the UPS represents the energy lost or inefficiency.

The UPS inefficiency can cause losses of up to 20% of the incoming mains power: a significant value which data center operators, public utility companies and energy managers must always consider. The inefficiency of the UPS, necessary to protect critical mission loads even just of medium size, can be quantified in an annual waste of hundreds or even thousands of kilowatt hours.

THE ADVANTAGES OF THE LEGRAND UPS

By installing high-efficiency static continuity units (UPS) one can considerably reduce the energy consumptions with a consequent cost saving in the bill, a saving which increases considerably in the case of industry, hospitals and other structures which have high and constant energy consumptions.

Legrand UPS, which have always featured high performance but low power consumption (high energy efficiency), represent an excellent investment.

In particular the Modular Three-phase range (TRIMOD HE and ARCHIMOD HE), thanks to its high efficiency, allows you to obtain a considerable saving in management costs.





MODULAR UPS
from 1.25 to 480 kW



TRIMOD HE
VFI three-phase
modular UPS
from 10 up to
60 kVA



ARCHIMOD HE
VFI three-phase
modular UPS
from 20 up to
120 kVA



**ARCHIMOD
HE240/480**
VFI three-phase
modular UPS
from 240 to 480kW

RANGE FEATURES
from 1.25 to 480 kW

Scalable

The UPS can be sized as necessary, without excluding any future implementations.

Adaptable

They are made up of "STANDARD" modules which can be added to existing machines to extend both power and independence.

Redundant

They guarantee maximum redundancy levels thanks to the innovative three-phase system made up of individual single-phase modules.

→ Efficient Energy Distribution | UPS "Uninterruptible Power Supply"

Trimod HE Archimod HE



Legrand's modular UPS know-how dates back more than 20 years, when the first modular UPS was launched in 1993. From then on the continuous firmware development and the constant research activity in the field of power and control hardware components mean that the reliability and system quality of Legrand UPS have improved continuously.

Ongoing research coupled with modern production methods have allowed Legrand to propose a cutting-edge product with performance at the top of the market: efficiency certified up to 96% and unit power factor.

TRIMOD HE and ARCHIMOD HE, with high-yield components and structures which optimize space, are the ideal solution for advanced energy management and containing costs.

**kVA = kW
POWER
FACTOR** 1 

MORE POWER

The unit power factor of the TRIMOD HE and ARCHIMOD HE UPS guarantees maximum real power; 11% more than competing products with power factor 0.9 and a good 25% more than products with power factor 0.8.

MORE EFFICIENCY

Among the highest market values which guarantee up to 4% more efficiency with respect to the minimum values required by the European Code of Conduct.

96%

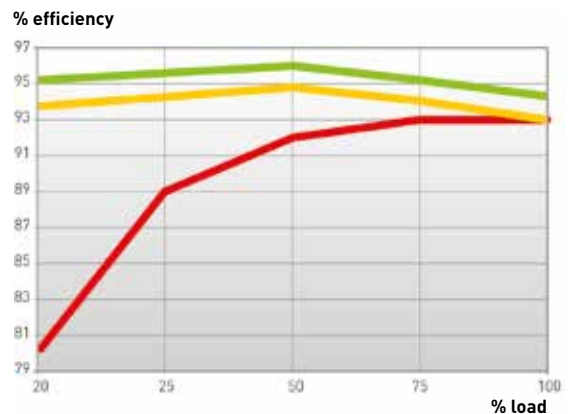

TRIMOD HE and ARCHIMOD HE
Code of Conduct (for 40 < 200 kVA UPS)
Code of Conduct (for 20 < 40 kVA UPS)



FLEXIBILITY, MODULARITY, SCALABILITY

POWER GRANULARITY

The three-phase UPS are made up of individual redundant and self-configurable single-phase modules which allow fast and safe power increments.

OPTIMISATION OF THE OPERATIONS

The power modules, with small dimensions and low weights (only 8.5 kg) facilitate UPS management in the transport and installation phases and in maintenance operations.

AUTONOMY SCALABILITY

Depending on the UPS power and the autonomy requirement the expansion may take place either in the same cabinet, adding battery panels, or in extra battery cabinets. Compact non-modular battery cabinets are available which allow a further extension of the autonomy time, even up to hours.



Redundancy on the single-phase load

In a system with three-phase power supply and one-phase load, when there is a fault on one of the modules there is no loss of power because it is supplied by other operating modules.

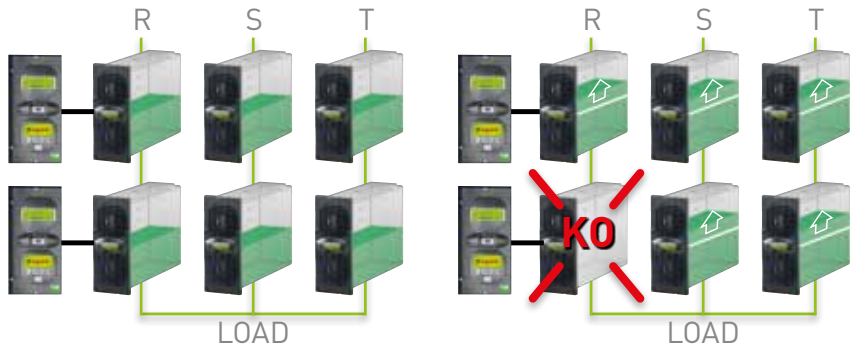

Phase redundancy

In a system with three independent outputs the redundancy can be set up on the single phases. If there is a fault on one of the power modules the modules of the same phase make up for the lack of the faulty module.

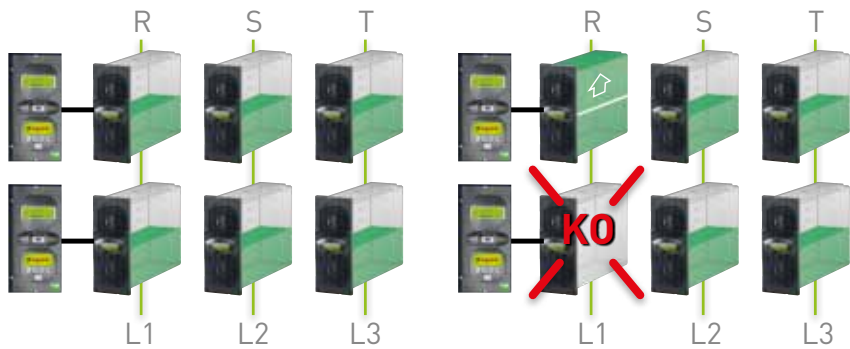

Control redundancy

In UPS made up of several command modules, if one of them is faulty only the modules it controls switch off. Continuity of service is however guaranteed by the automatic distribution of the power lost over the other modules.



OTHER REDUNDANCY LEVELS

Thanks to the construction technology of the TRIMOD HE and ARCHIMOD HE UPS various redundancy levels can be set, so that maximum continuity of service is always guaranteed.

→ Efficient Energy Distribution

EcoBatibox™

Flush-mounting boxes for dry partitions



VANTAGE

- Optimum savings
- Enhanced airtightness
- Optimum space for wiring

Improve occupants' comfort and the internal air quality.

Optimum savings by combining blanking plates with EcoBatibox boxes.

Enhanced airtightness thanks to flexible entries wide enough for spiral conduits.

Wide flange, retractable gripping clamps.

Optimum wiring space. Opening entries made easier by the detachable tab.

ECOBATIBOX, LOWER ENERGY CONSUMPTION

Eliminate uncontrolled air infiltration and cut the building's energy bills.

Modular EcoBatibox boxes and membranes which remain flexible in any climate can stop energy losses between the electrical panel and the wiring accessory.



For Italian Standard boxes available with: 2,3,4,6 and 3+3 modules.



For other Standard boxes available with: 1,2 3 and 4 gangs.



Efficient Energy Data Center



Cold corridor

[page 59](#)



Air conditioning

[page 63](#)



Metering with smart PDU

[page 66](#)

→ Efficient Energy Data Center

Context & issues

Data centers consume a great deal of energy: 322 TWh in 2012, i.e. 1.8% of global energy consumption*.

ENERGY-INTENSIVE BUILDINGS

For example:

- a typical data center consumes 10 to 100 times more energy per m² than a standard office building
- the consumption of a 10,000 m² data center is the same as that of a town with 50,000 inhabitants
- over 10 years, the operating cost of a data center is the same as its installation cost
- the electricity bill represents 10 to 15% of the operating cost

The building infrastructure currently represents close to half of the total energy consumption.

AN INCREASINGLY LARGE ECOLOGICAL FOOTPRINT

The ecological footprint of data centers is constantly increasing: it is estimated that in the next 10 years there will be 30 times more data (90% of which will not be structured) and significant more servers.

At this rate, energy requirements could double within 5 years.

Reducing the carbon footprint (one of the main concerns of stakeholders) and improving the energy efficiency of data centers is therefore vital in order to reduce consumption and costs.

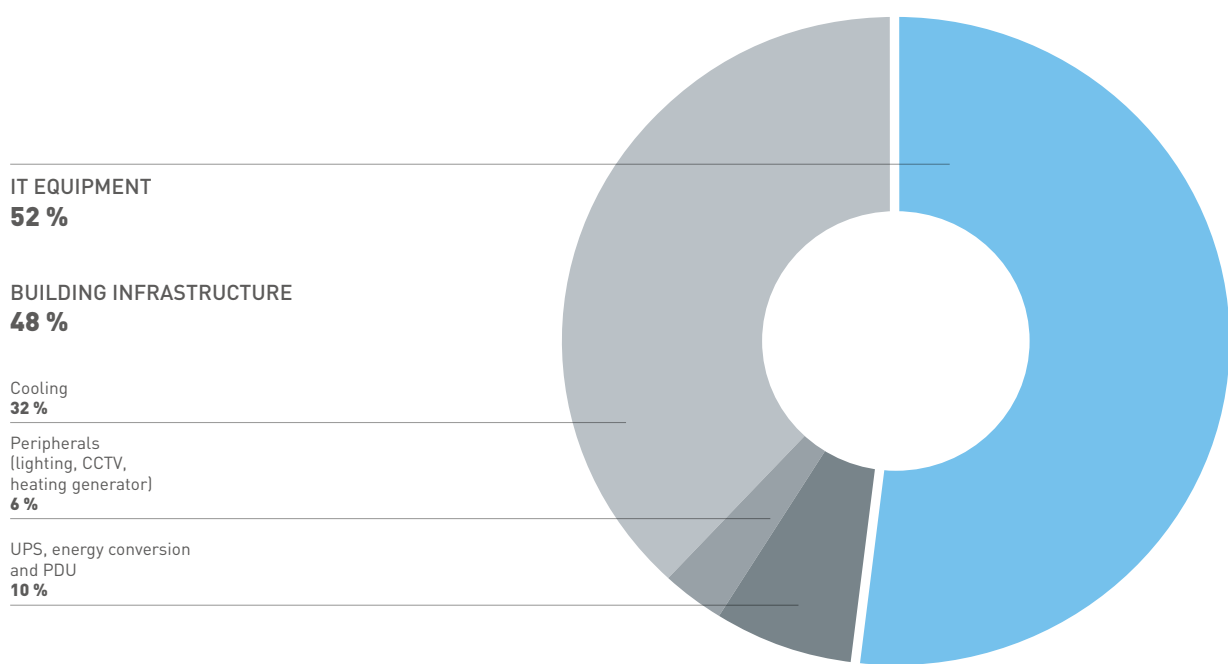

* Source: DataCenterDynamics

→ Efficient Energy Data Center

Legrand's response

OBJECTIVE: REDUCE THE PUE

The PUE (Power Usage Effectiveness) is an indicator for measuring the energy efficiency of a data center by working out the ratio of the total consumption of the data center to that of the computer and telecoms (IT) equipment. The Green Grid, an international consortium set up to improve the efficiency of data center resources, has defined several PUE levels:

■ LEVEL 0 PUE

This measurement compares the amount of electricity entering the data center with the amount of power consumed by the IT equipment. The new definition specifies that the measurements must be taken during consumption peaks, and behind the UPS. Even if the measurements are increased to regular intervals, an energy efficiency ratio at maximum load is obtained, which is not very representative of the activity of the company.

■ Basic PUE (level 1)

This measurement includes the level 0 requirements and stipulates conversion of all measurements into kilowatt-hour (kWh). It is more precise than level 0 because it also includes energy sources other than mains electricity. PUE1 is calculated over a 12-month period.

■ Intermediate PUE (level 2)

This measurement includes the level 1 requirements. However the IT consumption is measured at the PDUs (Power Distribution Units). A clear distinction is therefore made between the infrastructure and the IT equipment and it is easier to measure a pPUE (partial PUE).

■ Advanced PUE (level 3)

This measurement includes the level 2 requirements. It refines them by requiring the IT consumption to be measured at device level.

THREE POSSIBLE ACTIONS TO REDUCE THE PUE:

- optimising the cooling solutions
- reducing power losses
- make use of performance indicators

NOTE

4 The Green Grid and ISO/IEC are proposing 4 additional indicators to refine the assessment of the ecological footprint of a data center.

- the Green Energy Coefficient (GEC): this quantifies the proportion of renewable energy consumed by a data center
- the Energy Reuse Factor (ERF): this measures the amount of energy used outside the data center
- the Carbon Usage Effectiveness (CUE): this extrapolates a greenhouse gas emission volume based on the electricity consumption of the data center
- The Water Usage Effectiveness (WUE): this measures the amount of water used in the data center



For further information, go to

www.thegreengrid.org

A data center with optimum efficiency will be PUE 1, whereas the average global PUE of a data center is between 1.8 and 1.89 (source: Uptime Institute survey 2012). Reducing this is therefore a priority in order to ensure that the infrastructure provides ever-higher performance.

1,8 < AVERAGE GLOBAL PUE < 1,89



→ Efficient Energy Data Center

Optimize the cooling solution

The cooling systems are the main item of consumption in a Data center.

To reduce the energy consumption, the consumption by the server cooling systems must above all be reduced.

This involves:

- an optimized design of the white room
- selecting the right cooling solutions

To obtain the most appropriate solutions, it is necessary first of all to know the class of Data center concerned (see opposite). These solutions will then facilitate the implementation of a global cooling system called "free cooling".

In the context of a free cooling installation, several Legrand cooling solutions for the secondary circuit can be used to optimize the air conditioning.

They comply with 2 major thermodynamic principles:

- **Isolation of the hot air from the cold air**
This enables optimum management of air leaks and increases the cooling capacity
- **Optimisation of the cold air circuit**
Objective: minimize the air friction losses

ISOLATION OF THE HOT AIR FROM THE COLD AIR

Hot Corridor/Cold Corridor solutions

These consist of separating hot and cold corridors for easier, optimized air distribution.

Cold Corridor Solutions

In addition to simply separating the air flows by creating dedicated corridors, the Cold Corridor enables the corridors to be contained for optimized cooling.

The hot air and cold air are separated when the room is designed, using roofs, panels and doors (at the entrance and exit). This very effectively reduces the energy consumption of the air conditioning units (visible reduction via the air conditioning unit consumption reports). The Cold Corridor provides an average of 30% energy savings.

THE LEGRAND ADVANTAGE

Thanks to its worldwide network of partners, Legrand supports you during the decisive stages of your project:

- selection of the right solutions when defining the white room's design
- sizing of the cooling solution in relation to the power of the servers

OPTIMISATION OF THE COLD AIR CIRCUIT

Cooling the room

This is done using CRAC (Computer Room Air Conditioning) units.

Traditionally, the cold air is sent into the false floor at a slightly higher pressure and exits via perforated tiles in the Cold Corridor. The hot air is evacuated in the hot corridor and reprocessed by the unit.

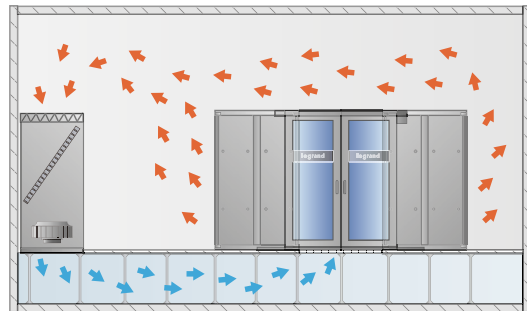

Principle of the room cooling system

Cold Corridor[®]
AN AVERAGE OF **30%** ENERGY SAVINGS



Free cooling

Free cooling consists of cooling a building by ventilation using the free energy of the external air or water when it is at a temperature below the required internal conditions. This system also reduces the need to use cooling units, which leads to a reduction in energy bills and improved efficiency of the whole installation (PUE and carbon footprint).

Free cooling includes overall management solutions via the primary cooling circuit and targeted management solutions in the white room via the secondary cooling circuit.

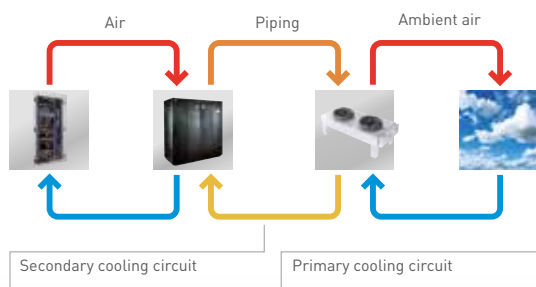

Standards

The class (A1 to A4) of a data center, defined by the ASHRAE standard, is assigned according to the equipment in the data center and its specific environmental features.

Equipment (ASHRAE - 2011 Thermal Guidelines)

2011 classes	2008 classes	Applications	IT Equipment	Environmental control
A1	1	DATA CENTERS	Enterprise servers, storage products	Tightly controlled
A2	2		Volume servers, storage products, personal computers, workstations	Some control
A3	NA			
A4	NA			

Class A1:

typically a data center with tightly controlled environmental parameters (dew point, temperature, and relative humidity) and mission critical operations.

Classes A2/A3/A4:

typically an information technology space or office or lab environment with some control of environmental parameters (dew point, temperature, and relative humidity).



OPTIMISATION OF THE COLD AIR CIRCUIT (continued)

Row-based cooling solutions

These cooling solutions integrated in the corridor (in or between the cabinets) reduce the complexity of the installation and provide cooling as close as possible to the server.

Particularly suitable for high density solutions or rooms without false floors, these solutions optimize the air flow so that it is as short as possible, which results in lower losses.

The H2O system

Commonly called a chilled water system it uses water for exchanging thermal energy between the secondary system and the primary outdoor system. When the system is running outside a water/glycol mixture is used as a coolant to prevent freezing. The system can be designed as a single loop system avoiding an extra heat exchanger and therefore maximizing the capability of free cooling. The water infrastructure is commonly managed as a circuit for a whole room or is part of a complete building.



Example of H2O in Cold Corridor

The Direct Expansion (DX) system

In this direct expansion system, the coolant in the refrigerating machine circulates in the exchangers in contact with the internal air (evaporator) and the external air (air condenser). This is a closed circuit in which each indoor unit is associated with one outdoor unit.



Example of DX in closed loop

→ Efficient Energy Data Center

Air conditioning

H2O installation diagram

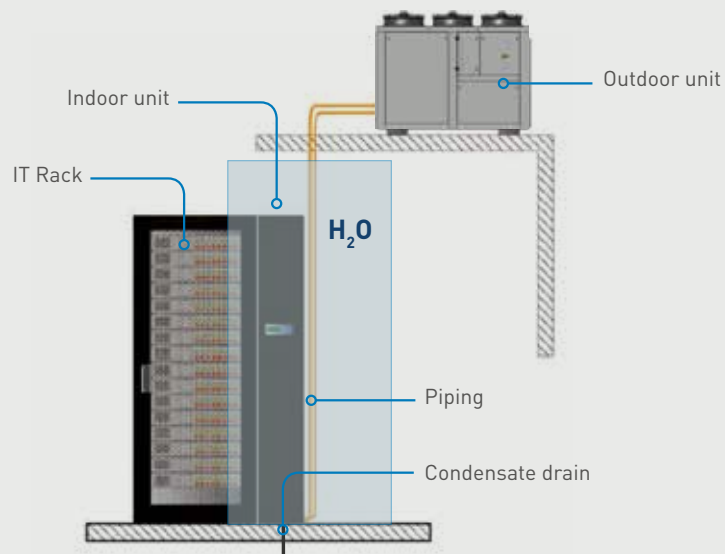

DX installation diagram

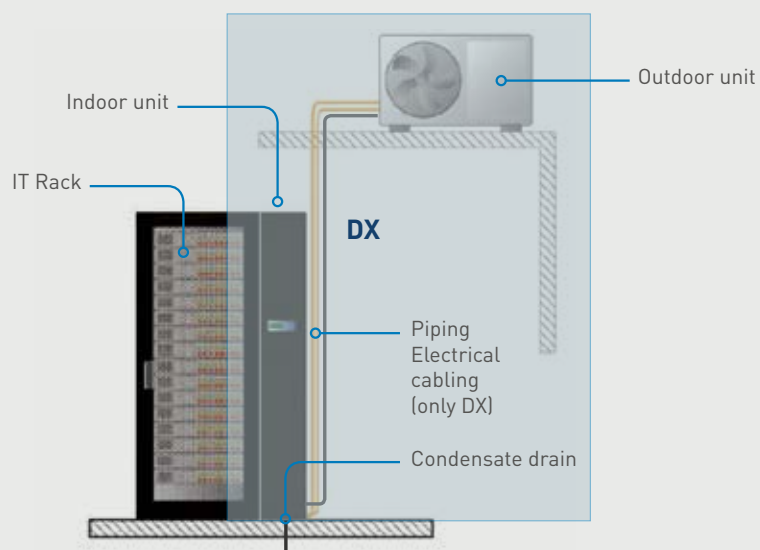

→ Efficient Energy Data Center | Air Conditioning

Reduce power losses

The objective is to reduce power losses so as to increase the efficiency of the electrical infrastructure. Power losses connected with energy conversion and UPSs currently represent around 10% of the total energy consumption of a data center, where the cooling alone represents 32%.

Given the efforts made with regard to cooling, particularly through designs enabling the use of free cooling, these power losses will account for a large part of the data center's energy bill.

In order to increase the efficiency of the electrical infrastructure, it is therefore necessary to look into solutions that will reduce this percentage, in particular via the power supply and distribution systems. Various products, providing high performance installations, improve the quality of the energy and limit power losses, thus reducing the environmental footprint:

- **Uninterruptible power supplies (UPS)**
These enable the power demand to be as close as possible to the actual requirements.
- **Green T.HE hv/lv transformers**
(Green Transformer High Efficiency)
These high efficiency transformers ensure effective energy efficiency.
- **Capacitor banks**
These optimize the reactive power and reduce the apparent power of the installation.

PROJECTION OF LOSSES BY IMPROVING THE PUE

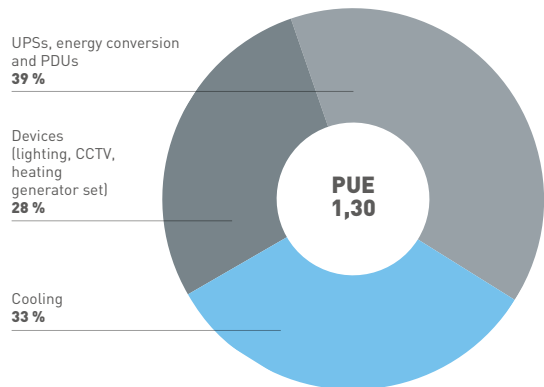
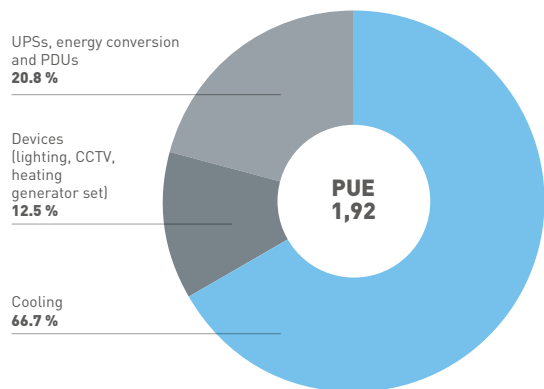

Standards

Various normative documents and certifications guarantee the quality of the supply and distribution systems, thus limiting power losses.

- Standard EN 62040 & European Code of Conduct on the efficiency and quality of UPS**
 For uninterruptible power supply (UPS) systems.

It defines much lower levels of no-load/on load transformer losses and is easier to read:

It also establishes noise limits to ensure a level of comfort and limit all disturbance inside the building.

- Standards IEC 60831-1 and 60831-2**
 These standards establish the electrical features and the mechanical impact tests for the capacitors.
- Standards IEC CEI 61439-1 and IEC CEI 61439-2**
 For low-voltage switchgear and control gear assemblies.

No-Load Losses

According to EN 50541-1

P_o

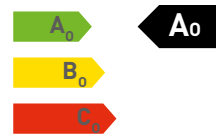

Losses that are still present when the transformer is connected to the net (8760 hours per year) and are independent of the charge

On Load Losses

According to EN 50541-1

P_k

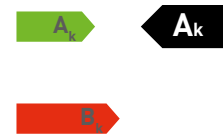

Losses that are quadratic with the charge ($P_k \propto I^2$)

NOTE

The reduction of power losses must be worked at on a daily basis, via careful management of the energy requirements. Those responsible for operating a data center must therefore pay attention to the flow and quality of the incoming energy in order to adapt the power demand to the actual requirements of the data center and ensure optimum use of the power received.

As the various power devices operate efficiently at low load conditions (a transformer used at 10% of its capacity is 3 times less efficient than at 60% of its capacity, likewise for inverters and air conditioning units.), their energy management will be optimized and power losses limited.



→ Efficient Energy Data Center

PX[®] intelligent rack PDUs

RACK POWER DISTRIBUTION UNITS FOR YOUR DATA CENTER

Raritan's PX intelligent rack PDU series offers more than just power distribution - it's a launch pad for real-time remote power monitoring, environmental sensors, data center infrastructure management, and so much more.

The PX series offers hundreds of models to power all your data center applications, including models with outlet switching, individual outlet metering, high power for blade servers and high density applications, and 400V three-phase power distribution.

Raritan offers a variety of intelligent rack power distribution models that satisfy all of your metering requirements. Get certain off-the-shelf models delivered in as little as a few days, or have your PDUs engineered to meet your unique application.

In the next few pages you'll learn how Raritan was able to take over twenty-five years of embedded computing expertise and customer insights to reinvent the rack PDU and set the gold standard for data center power chain management. Find out why some of the world's largest data centers trust Raritan's intelligent rack PDUs to power their mission critical equipment.



TYPE OF RARITAN PX SERIES INTELLIGENT PDUS

Family	Outlet Switching	Outlet Metering	Inlet Metering	Breaker Metering
PX-5000	●	●	●	●
PX-4000		●	●	●
PX-2000	●		●	●
PX-1000			●	●

INDUSTRY LEADING INNOVATION

Soaring energy prices, greater competition in the marketplace, and global concerns over climate change are forcing companies to reconsider how they utilize power in the most valuable and energy intensive resource they own – the data center. It's why data centers are now so focused on cutting operational costs by improving efficiencies, and making optimal use of energy, space, and cooling.

They're also tasked with the most important responsibility of all: to make sure the data, services, and applications that we all rely on are always available. Not surprisingly, many of the major strategies being employed to address these challenges depend on capabilities that were not present in the simple commodity power strips of a few years ago.

Consider how Raritan's intelligent rack power distribution units (iPDUs) help data centers to achieve those goals:

+/- 1%



- **KWH METERING ACCURACY**

Accurate kWh metering allows you to measure actual energy usage for accurate customer or department charge-back billing. The data can be used to encourage energy efficient behaviour among users, establish power consumption baselines, and analyze the effect of efficiency initiatives.

- **DCIM MONITORING**

Power IQ® DCIM Monitoring software automatically gathers power, energy, and environmental data from your intelligent PDUs and connected devices to help maintain uptime, improve capacity planning, and support energy efficiency initiatives. With Raritan's intelligent rack concept you have one-click access to rack power, cooling, airflow, events, and much more. Data center health maps, power analytics, cooling charts, and reports alert you to potential trouble and help you to understand real-time power load, trends, and capacity at the data center, room, rack, or customer level. DCIM puts the most powerful information you need to manage your data center effectively right at your fingertips.

- **ENERGY EFFICIENT LATCHING RELAYS**

Latching bistable relays only require power to switch from one state to another so PDUs consume 67% less energy, produce less heat, and can be configured to return to pre-outage state instantly, or leverage patent-pending outlet sequencing technology that minimizes inrush current.

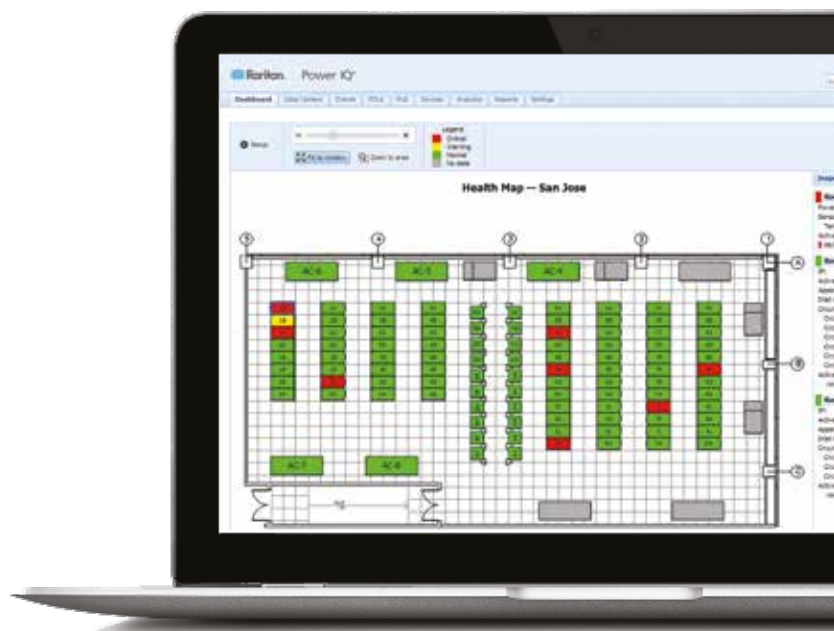



FOR DENSE, HIGH POWER RACKS

Whether you operate a large, medium, or small data center, it may be time for you to consider deploying high power to at least some of your racks. Good candidates are racks that will be packed with 1U servers, network switches, blade servers, network storage devices, and other high density applications. Consider how Raritan's three phase, high voltage rack PDUs can increase energy savings and increase capacity:

55kW



■ 400V THREE-PHASE MODELS

We offer a broad range of 400V three-phase high power models that support up to 55kW per rack PDU. Running higher voltages at lower currents means smaller and fewer cables, which use less copper, weigh less, occupy less space, and cost less.

Plugs and receptacles are also less expensive at higher voltages and lower current ratings, and additional savings are achieved by eliminating voltage transformations.

■ PDVIEW APP

Turn your tablet or phone into a remote display. Raritan's PDView app provides at-the-rack display of all critical data.



Endorser of the EU Code of Conduct on Data Centre Energy Efficiency

Formulated by the EU's Joint Research Centre, the Code is a measured response to the energy challenges the EU faces. It's aim is to encourage companies with data centers to reduce energy consumption while ensuring business objectives continue to be met.

As an endorser, Raritan have pledged to implement the Code's ethos through devising products and services that help organizations to bring their data centers into line with its best practice recommendations.



→ Efficient Energy Data Center

Environmental sensor

MONITOR YOUR DATA CENTER WITH ENVIRONMENTAL MONITORING SOLUTIONS



Raritan environmental solutions feature sensors for monitoring temperature, humidity, airflow, air pressure, water/leaks, contact closures, motion around a cabinet, and vibration. Environment data is instantly sent to Power IQ® DCIM Monitoring software to provide a complete picture of data center conditions at the rack, aisle, and facility level while alerting operators to risks or potential threats in real-time and revealing trends over time.

The sensors are deployed as plug-and-play options for the PX intelligent rack PDU series, EMX rack controllers, PX inline meters, rack transfer switches, and branch circuit monitors. Raritan's environment sensors make it easy to identify hot spots, cool equipment optimally, prevent downtime, and maintain facility security.

WHY ARE ENVIRONMENT SENSORS USED IN ALL MODERN DATA CENTERS?

Environment sensors are an easy to install, cost-effective way to reduce energy costs, improve reliability, and increase capacity for future data center growth. By using environmental sensors you can optimize your data center ecosystem to ensure that you are meeting equipment guidelines, reducing operational costs, deferring capital investments, and improving your power usage effectiveness (PUE).



SENSORS IN YOUR DATA CENTER

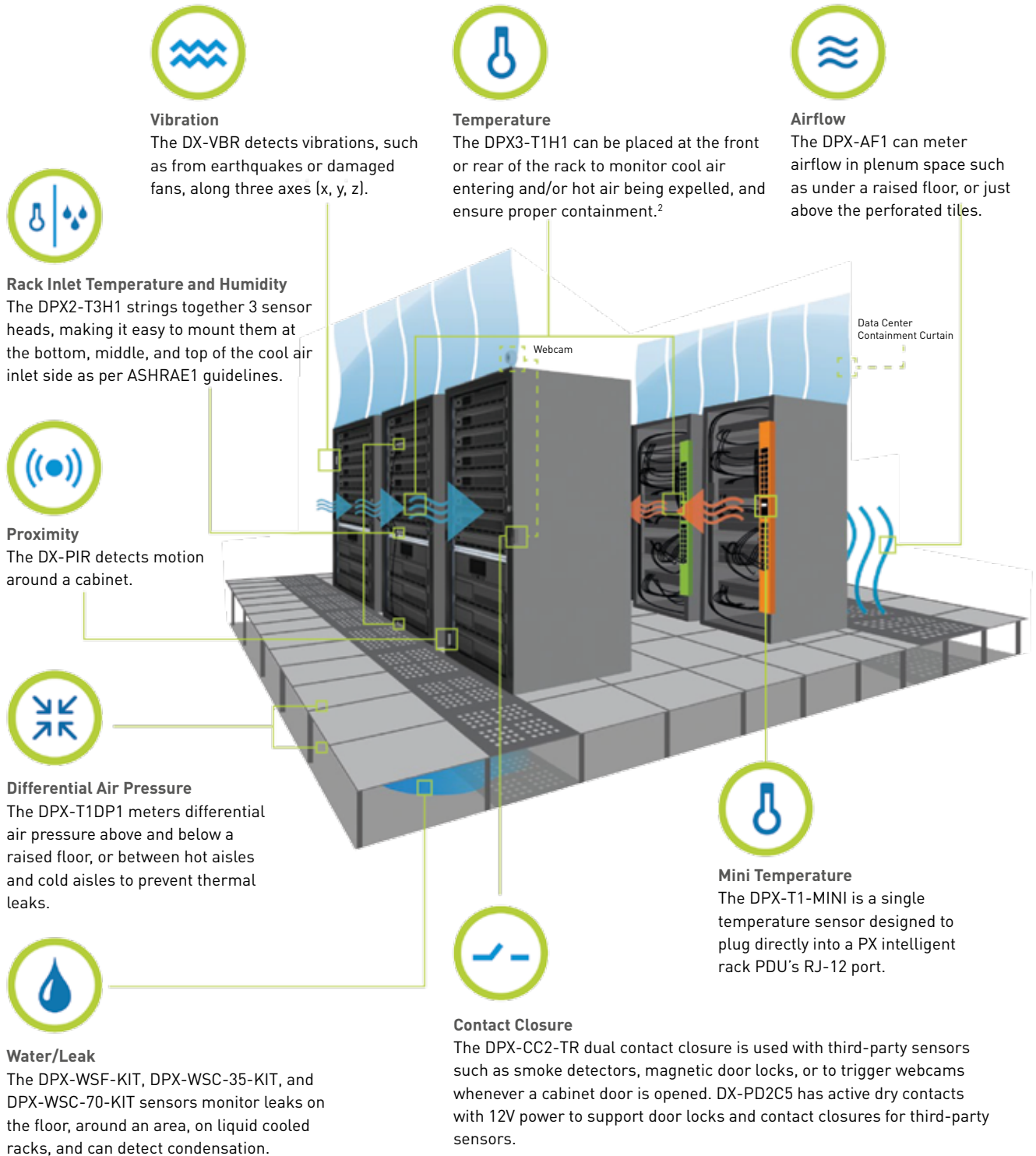

¹ The American Society of Heating, Refrigerating and Air-Conditioning Engineers (ASHRAE) recommends measuring the cool air entering IT equipment near the bottom, in the middle, and near the top of each IT rack.

² Additional temperature and humidity sensor options are available.

→ Efficient Energy Data Center | Environmental sensor

Basic vs. Intelligent PDUs (differences)

MAJOR CHALLENGES NEARLY ALL DATA CENTERS NOW FACE

The single most important objective of the data center is to ensure business continuity. The rack PDU helps to do this by delivering stable, reliable, and adequate power to all devices – servers, storage, and networking equipment – plugged into it. But, consider some of the other major challenges faced by data centers.

- Power Capacity Management and Provisioning
- Energy Management
- Environment Management
- Physical and Network Security
- Computing Capacity Demand
- Asset and Change Management



MANAGING DATA CENTER ENVIRONMENTS

Intelligent PDUs power plug-and-play environment sensors that help data centers make better use of cooling resources.

- Environmental monitoring sensors for temperature, humidity, airflow, and air pressure, give you the confidence to raise ambient temperatures and adjust fan speeds in CRAHs and CRACs.
- Sensor data viewed from DCIM Monitoring Software allows you to see temperature in real time across an entire data center or several data centers.
- Sensors allow you to optimize your data center ecosystem to ensure that you are meeting guidelines and set points, reducing operational costs, and improving your PUE.
- Environmental sensor data can also help you to discover and reclaim unused data center capacity and defer capital investments in equipment and facilities.



→ Efficient Energy Data Center | Environmental sensor

Real world results with PDUS



CISCO SAVES \$8.6M ANNUALLY BY DEPLOYING INTELLIGENT PDUS

In 2011, when Cisco sought to reduce its energy consumption and costs, its labs were an obvious target: they accounted for 60% of the company's total power use, yet occupied only about 10% of its real-estate space. The labs consumed more than 900MWh of power a year, had a combined annual electricity bill of more than \$80M, and were the single largest source of operational greenhouse gas (GHG) emissions for the company.

The two-year initiative was completed in July 2013. Though the company saved \$9million dollars total, over \$8.6 million in savings alone were from intelligent PDUs deployed in all new, existing, and retrofit labs.

One key feature that allowed the company to saved big was having the ability to power off lab equipment while not in use.



EBAY'S NEW DATA CENTERS ARE TWICE AS RELIABLE AND 50% LESS EXPENSIVE TO OPERATE

As one of the world's largest Internet commerce platforms, eBay demands extreme data center reliability; any downtime would impact transactions worth more than \$2,000 a second. Thus its global data center team must excel simultaneously in delivering uptime and flexibility, while keeping costs down – a truly complex challenge, requiring constant innovation to be successful.

To enable maximum savings, eBay deployed Intelligent rack PDUs that provide precise energy consumption data for every single power supply, of every single server.

This information passes upstream to eBay's building management and asset tracking systems in real time, achieving what Green Grid terms PUE Category 3 (or PUE3) monitoring.

"[Intelligent PDUs] can provide me with the precision required to calculate my true operational costs for every server, down to the last penny," says Dean Nelson, eBay's Senior Director of Data Center Strategy and Operations.



F5 NEVER RUNS OUT OF COOLING CAPACITY THANKS TO ENVIRONMENT SENSORS

F5's product development lab in Seattle, WA, houses the work of 25 separate technology teams, and provides access to more than 300 developers and testers who test and deploy new software services while shuffling equipment in and out of the lab. So when the lab began running out of power and cooling capacity, something had to be done urgently. "First we wanted to monitor all of the power for all of the teams that were in our lab. We wanted to see what they were using and we needed to be able to monitor at a high level" said Kiel Anderson, Senior Lab Network

Engineer at F5. "Our next problem was that we were running out of cooling. We had a total AC outage here once and our entire lab had no air conditioning for four hours. About 30 minutes into it, it started getting too hot in there. These were both big drivers for pushing to get software for real-time monitoring," said Anderson.

DCIM software and environmental sensors were deployed as a part of a comprehensive iterative strategy that has produced a marked reduction in energy consumption and an increase in total capacity.



UF HEALTH SHANDS SAVES 50% IN ASSET TRACKING EFFICIENCY WITH DCIM OPERATIONS SOLUTION

When the Shands IT team in Gainesville, Florida became responsible for three additional data centers, the team began looking for new tools that would help answer what equipment was in each data center and exactly where every server, UPS, and device was located – and how they were connected. The old way of tracking IT assets, Excel spreadsheets and Visio floor plans, was not flexible enough to support the added scope of multiple remote data centers – nor the ever-increasing demands on IT to support changes for a growing business. The IT team

wanted a better and efficient way to track assets and capacity.

"We now have a seamless workflow process – from ticket creation to data center deployment. Requests come into the service desk, which then places the request into [DCIM Operations Software]. Based on space, power and network connectivity information, [DCIM]... helps pick an optimal location for placing the server," says Joseph Keena, Manager of Data Center Operations at UF Health Shands.



Active Energy Management



Energy Management:
Measure, report, status,
command & display data
on site or remotely

page 75



Measure of the
energy integrated to
Power devices or with
measuring central units

page 76



Energy Management
System

page 80



Building Management
System

page 88



Load shedding
equipment

page 90



Lighting management &
Lighting Control

page 92



A new management of
the lighting

page 106



HVAC control

page 121



Solar panel connection

page 126



Electrical vehicle
charging station

page 131

MEASURE, REPORT STATUS & COMMAND

The Legrand/BTicino MEASUREMENT and SUPERVISION system has been developed with the aim of managing energy consumptions inside the building, guaranteeing reliability and continuity of service, for maximum system efficiency.

SUPERVISION

Supervision is a computerized **control and monitoring technique for processes**.

In the measurement field, it is used as an umbrella term for all the aforementioned functions (display, monitor, control, set parameters, program).

Supervision concerns acquisition of data (measurements, alarms, status feedback, etc.) and process control (circuit breaker remote control, etc.). A supervision system helps control and optimize energy consumption at any time on the whole of the electrical network. It monitors all the equipment with respect to safety, control, speed of intervention and continuity of service.

Data retrieved concerning the equipment operating status, distributed power measurements and consumption can be exploited in order to set up a technical energy management solution.

The BTicino measurement and SUPERVISION system allows you to display all the electrical system parameters simply and immediately.

THE INTUITIVE DISPLAY, ACCESSIBLE TO ALL.

BTicino meets its customers' needs with a graphic interface which is easy and understandable even for unqualified people.

ALL THE LOADS

-  Heating
-  Air conditioning
-  Warm water
-  Ventilation
-  Lighting
-  Sockets

APPLICATION SECTORS

- **WELCOMING ESTABLISHMENTS:**
hotels, holiday resorts
- **WORKING ESTABLISHMENTS:**
banks, offices, schools
- **LOGISTIC ESTABLISHMENTS:**
warehouses
- **INFRASTRUCTURES AND PRODUCTION ESTABLISHMENTS:**
hospitals, office buildings

→ Active Energy Management

Energy Supervision Devices

TRADITIONAL

- Counters
- Measurement units

WITH INTEGRATED MEASUREMENT IN THE CIRCUIT BREAKERS

- Megatiker
- Megabreak

CONSUMPTION MANAGEMENT AND CONTROL

- Management software
- Dedicated web server

Knowing the consumptions is the first step of energy efficiency.



→ Active Energy Management | Energy Supervision Devices

Traditional measurement instruments



ENERGY METERS

They measure the electricity consumed in one-phase or three-phase circuits.

The main features are:

- measurement of the active and reactive energy
- RS485 communicating devices
- devices with impulse output
- MID homologation and certification corresponding to standard CEI EN 62053-21/23, CEI 61010-1

MULTIFUNCTION MEASUREMENT UNITS

With LCD display they can supply the measurement of: currents, voltages, active, reactive and apparent power, inside temperature and power factor.

The main features are:

- solutions for Din35 rail and 96x96mm panel
- RS485 communicating devices
- wide range of measured parameters
- compliance with regulations IEC 61557-12 and IEC 62053 -22/23
- they can be fitted with accessories such as memory, temperature and communication modules
- clear graphic interface and simple navigability

→ Active Energy Management | Energy Supervision Devices

IME marked products

From now on the Legrand Group can also offer IME brand products for measurement instruments. IME is a company specialized in display and measurement instruments, among the largest European companies of the sector.

IME has been purchased by the Legrand Group and has a turnover of about 25 M€.

Just a few of the products available in the catalogue are shown below. These are the main products which allow you to obtain energy efficiency.



RETROFIT KIT

A solution which makes the installation of an energy monitoring system on existing systems easier.

NEMO 96 HDLe

Flush mounting, 96x96mm - expandable with plug-in modules

NEMO 96 HD+

Connected on LV/MV networks by means of CT and VT flush mounting 96x96mm

PLUG-IN MODULES

The purpose of the plug-in modules is to add new functions to the Nemo 96 HD/HD+/HDLe models such as communication outputs, analogue outputs, alarms and memory.

→ Active Energy Management | Energy Supervision Devices

Circuit breakers with integrated measurement



MEGATIKER AND MEGABREAK

The new MEGATIKER and MEGABREAK circuit breakers integrate innovative functions such as energy measurement and the communication function for system supervision.

With the installation of these products one measures the most important parameters automatically, without making any modification to the system.

- Currents, voltages, powers
- Active and reactive energy
- Total harmonic distortion (THD)
- Power factor
- Frequencies

All the parameters under control without modifying the system.
QUICK, EASY AND COMPACT.

EMS CX³ Energy Management System

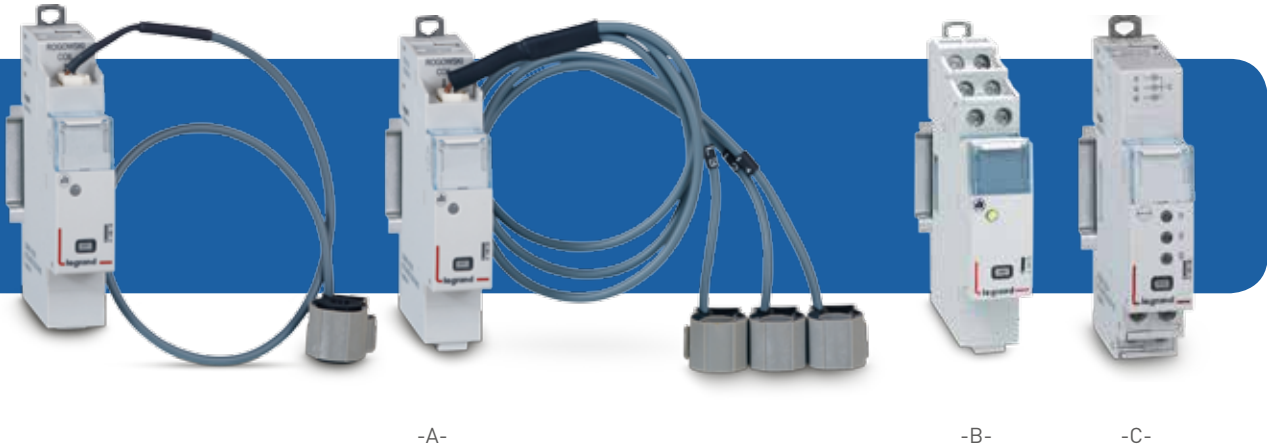

This complete and polyvalent energy management system is made up of various modules to measure and control modular equipment, such as power equipment and give their status, both locally and remotely. The ideal solution to **master the whole electrical system**.

COMPACT MEASUREMENT MODULES FOR VERY PRECISE DATA

- Current, simple and compound voltage
- Active/reactive and apparent energy
- Cos phi, frequency and harmonic rate

A - Measurement units with Rogowski closed compact coils to make measurements as a function of the reference of the single-phase or three-phase circuits up to 63 A

B - Measurement units to associate to all the types of transformer (5 A on the secondary), single-phase, three-phase, open or closed

C - Pulse concentrator. For collecting and transmitting 3 measurements taken from pulse energy meters (water, gas, electricity). 3 passive inputs fully programmable for units pulses and weight.

PERFORMANCE

Energy accuracy class:
0,5 (Ea, IEC/EN 61557-12).

Reactive energy accuracy class:
1 (Er_v, IEC/EN 61557-12).



Perfect integration of the EMS CX³ modules in new and existing installations.



OPTIMUM CONTROL AND STATUS REPORT FUNCTIONS

The status report modules allow you to know the status (start/stop) of tripped circuits or any faults on contacts, circuits or components locally or remotely.

D - Ultra compact State auxiliary + fault signalling contact module. 3 states in only ½ module wide. To be associated with modular Legrand devices.

E - Universal signalling module to be associated to power devices of any kind of state auxiliaries. Equipped with 3 fully customisable LED indicator to indicates



various type of information: contact positions, Power Protection device plugged-in/ drawn-out, etc.

The control module can control motorised loads or controls manually or automatically (deactivation/reactivation).

F - Universal Control module to remotely control different electrical loads or motorised control: Equipped with 2 fully customizable relays (contact type: 1NO, 1NC, NO+NC, 2NO ...) and function (maintained or momentary).

G - Control & state reporting module for Legrand modular latching relays and contactors. Allows to keep specificities of such devices e.g. contactor for peackour with or without handle, etc.



MAINTENANCE

- Alert when a fault or consumption threshold is reached to guarantee more targetted and effective action.
- Quicker action times thanks to a clear identification of the faulty circuit.
- Easier maintenance thanks to ingenious wiring on rail and/or compact communicating cords:
 - New projects: simple and quick installation
 - Existing systems: EMS CX³ modules which can be integrated in existing systems for updating

EASY

The communicating rail is positioned on all types of DIN rail or raised

SIMPLY

The connection with the supervision data is made by clipping the EMS CX³ modules onto the communicating rail

TEST, CONFIGURE AND DISPLAY ALL THE SYSTEM LOCALLY OR REMOTELY

An information display suitable for all needs.

LOCALLY

EMS CX³ MINI CONFIGURATOR

Optional if necessary: the mini configurator for all the EMS CX³ systems



For the installer:

- configure the system: thresholds, alarms without computer via IP connection
- plan: deactivation/reactivation
- address the modules
- test

For the user:

- display the consumptions, the alarms and control the devices

REMOTELY

FOR EMS CX³ AND EMDX³ ENERGY MANAGEMENT SOFTWARE



Control of the whole system

- Display data from energy efficiency equipment (EMDX³ and EMS CX³)
- Display the equipment status (on, off, faulty, etc...)
- Display alarms, thresholds, etc...
- Work on power and modular protection devices
- Manage detailed reports of power consumptions
- Manage Green Up columns (for the web server only)

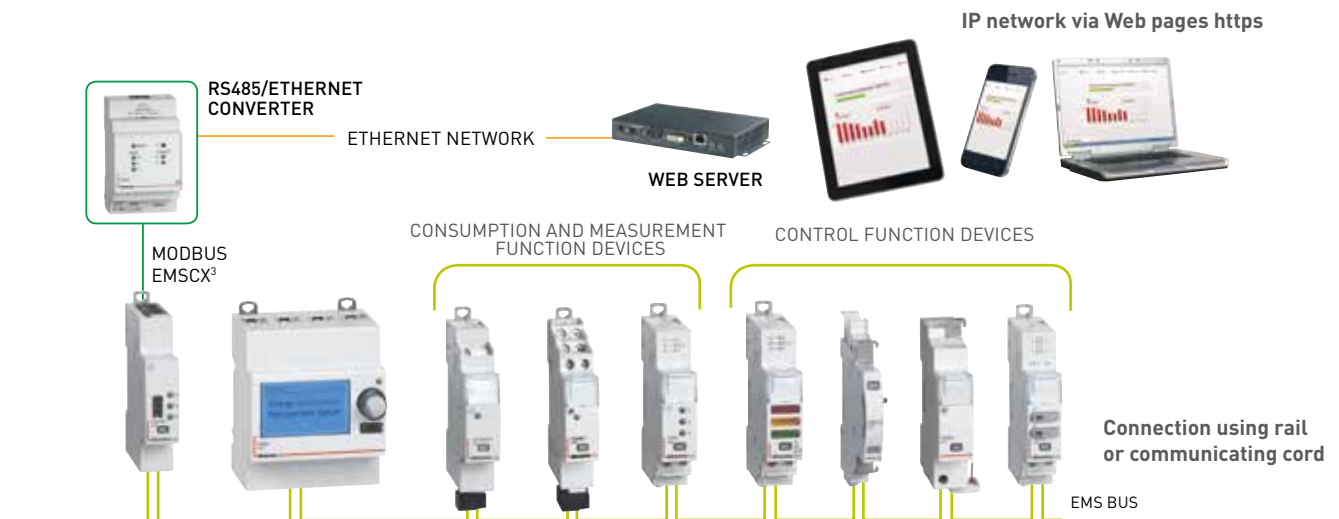

OPERATION

- Easier use: analysis of all the energy parameters (monitoring of consumptions, management of alarms etc...) and real-time system control (remote control, deactivation, status signalling, etc...).
- "Open" system: data output in IP to connect to the computer infrastructures (Intranet and/or Internet).

SAVINGS

- Better monitoring of energy costs thanks to a constant and precise check of consumptions.
- Compactness of the CS3 modules which generally allows retention of the initial dimensions of the housings.
- System check at all levels (measurement, control and status signalling) to offer more levers to control the electrical system.

→ Active Energy Management

Control all the electrical installation

Several solutions to meet all the needs of remote display and energy control



DISPLAY, MANAGE AND WORK



Total or partial consumption by zones, circuits or devices



Display data from energy efficiency equipment (EMDX³ and EMS CX³)

Manage detailed reports of consumptions (pdf documents)



Display the equipment status (on, off, faulty, etc...)

Display alarms, thresholds, etc...

Act on modular protection equipment and power equipment

Clear symbols for quick identification of the functions associated to a circuit



ENERGY MANAGER SOFTWARE "USB LICENSE KEY"



It exists for 32 or 255 Modbus addresses

Allows remote configuration, test, control and then display on one dedicated computer for:

- protection devices (DX³ add-on modules with integrated measurement central unit, DPX³ and DMX³)
- EMDX³ electricity meters
- multi-function measuring units
- EMS CX³ energy management system

Only on 1 computer

With license key ("Energie Manager" software) to display just on 1 PC

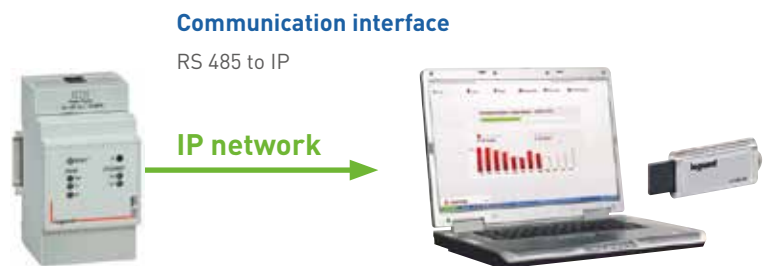

WEB SERVER ENERGY



It exists for 32 or 255 Modbus addresses

Allows remote configuration, test, control and then display on multi-supports devices data collected from:

- protection devices (DX³ add-on modules with integrated measurement central unit, DPX³ and DMX³)
- EMDX³ electricity meters
- multi-function measuring units
- EMS CX³ energy management system
- Green'Up electric charging points

On several supports

With Energy Web Server to display on 1 or several PCs, tablets, smartphones



INSTALLATION EXAMPLE FOR SERVICE MANAGER

Needs:

- measure the electricity, report the status, and work
- multiple display with various levels of data access

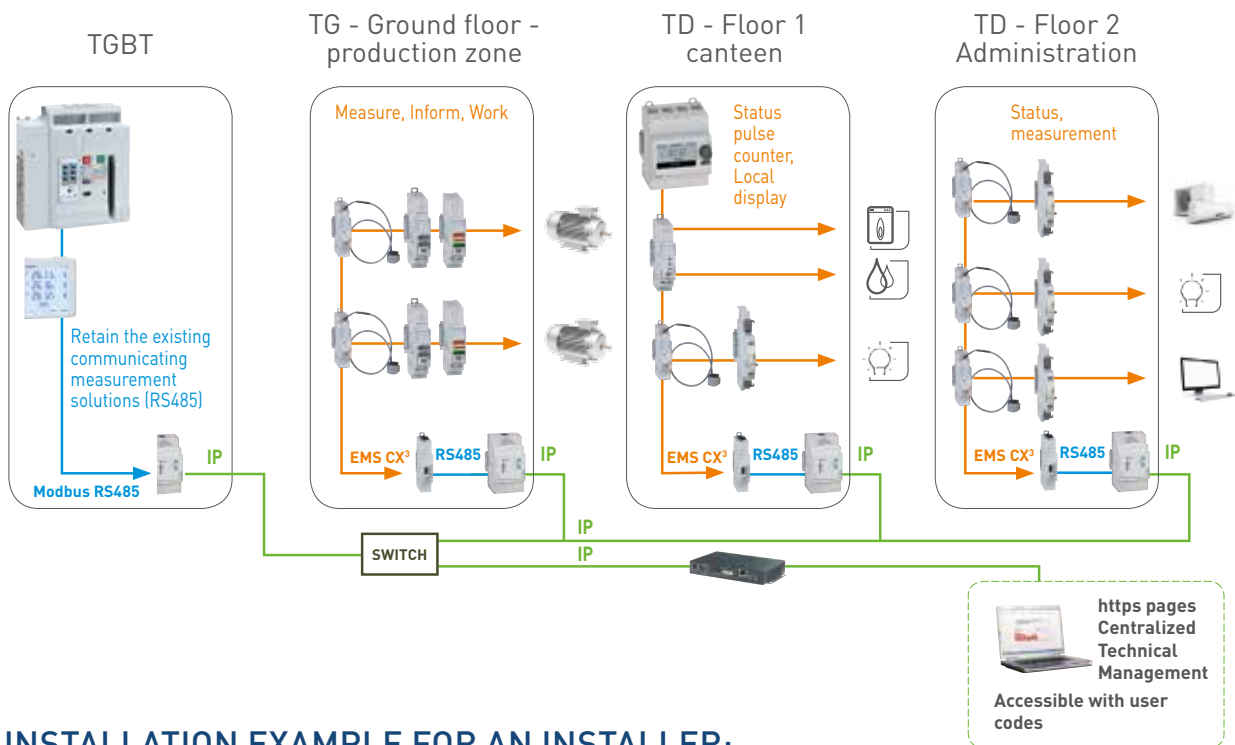



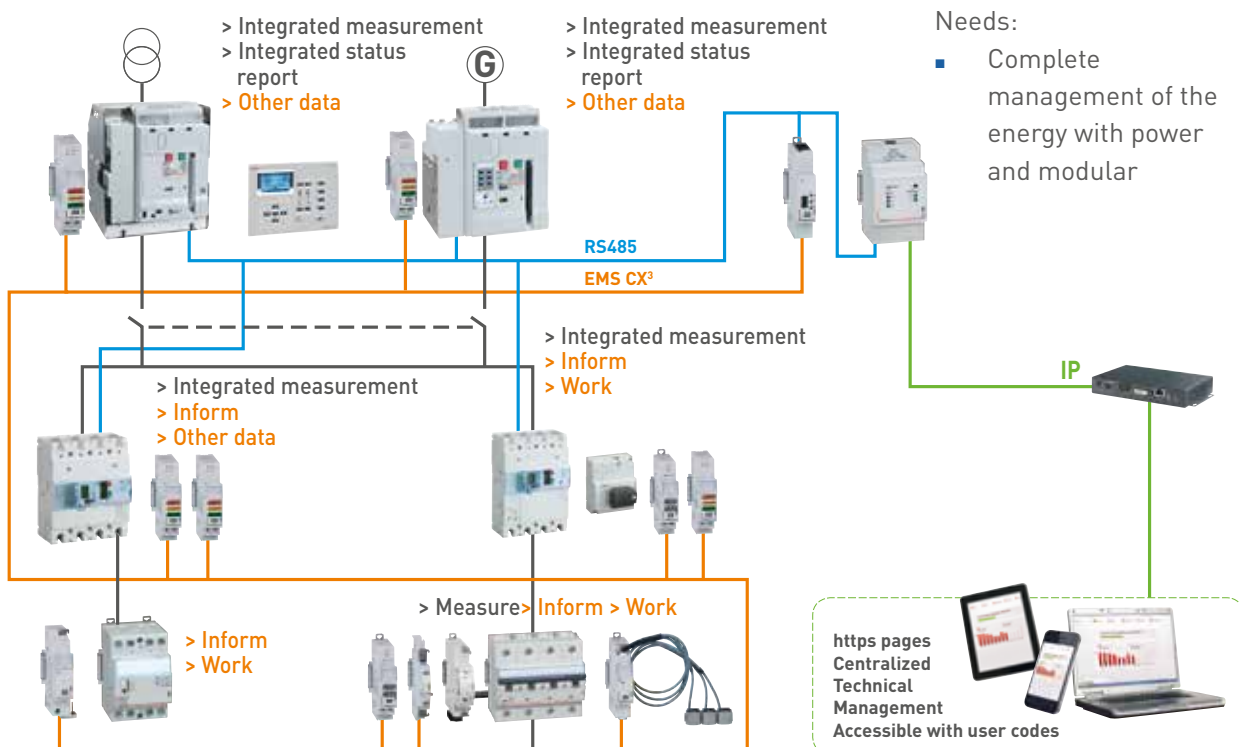









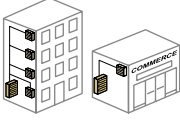





INSTALLATION EXAMPLE FOR AN INSTALLER: TGBT WITH MODULAR AND POWER

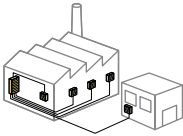

Needs:

- Complete management of the energy with power and modular

OVERVIEW: ENERGY MANAGEMENT OFFERS

INSTALLATION SITE	CONTROL AND NOTIFICATION	PROTECTION	
<p>Residential</p> 		<p>DX³ 1 MCB module</p> 	
<p>Collective residential and service sector</p> 	<p>DX³ Status auxiliaries and motorised control (except auto-reclosers which cannot be used in the home)</p>  <p>+</p> <p>RS 485 control and notification interface item 0 261 36</p> 		
	<p>EMS CX³ status report modules item 4 149 29/30</p>  <p>EMS CX³ control module item 4 149 32</p> 		
	<p>EMS CX³ module Control and status report module item 4 149 31</p> 	<p>Contactors</p> 	
<p>Service sector</p> 	<p>DPX³ Control and notification auxiliaries</p>  <p>+</p> <p>RS 485 control and notification interface item 0 261 36</p> 		
	<p>DMX³ Control and notification auxiliaries</p>  <p>+</p>		
	<p>EMS CX³ status report modules item 4 149 29/30</p>  <p>EMS CX³ control module item 4 149 32</p> 	<p>DMX³ or DPX³</p>	

1: use 1 interface per adaptable differential block
2: except DPX³ 630 and 1600 version S1

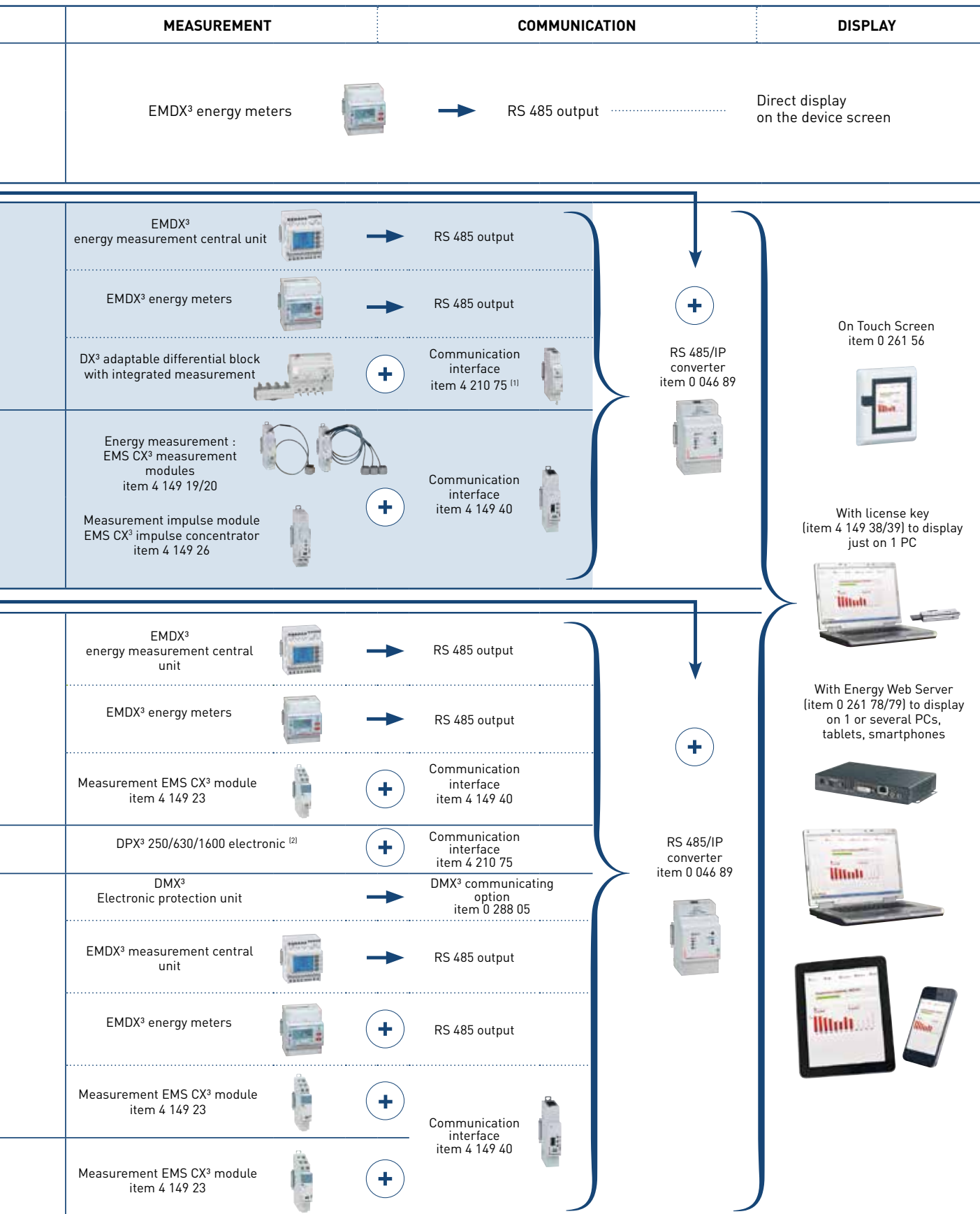

1: use 1 interface per adaptable differential block
 2: except DPX³ 630 and 1600 version S1

→ Active Energy Management

Building Energy Management System

Allows remote configuration, test, control and display, via a web browser on PCs, smartphones, web viewers, tables computers, of data collected from: protection devices (DX³ add-on modules with integrated measurement central unit, DPX³ and DMX³), EMDX³ electricity meters and multi-function measuring units and CX³ energy management system.

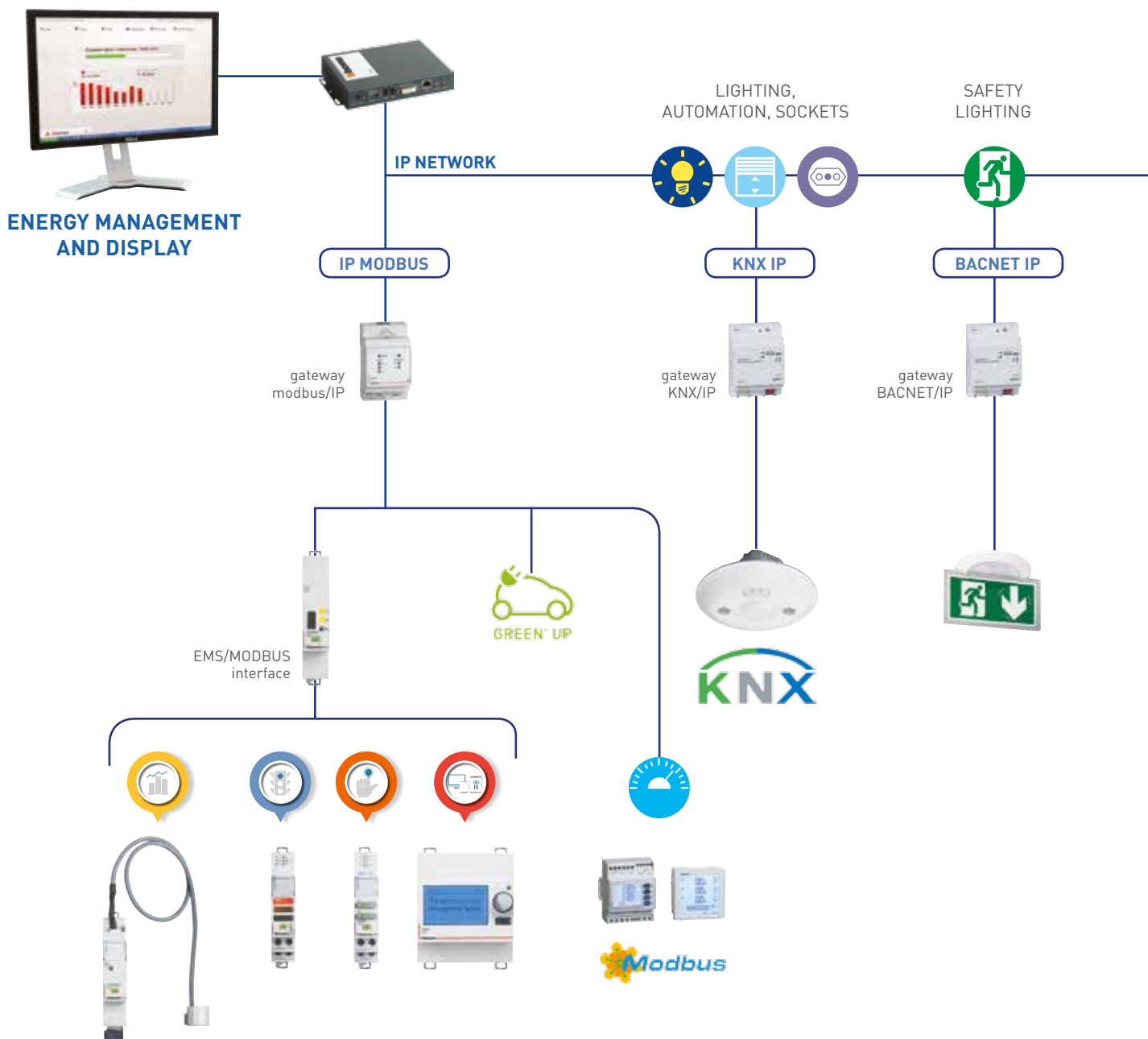

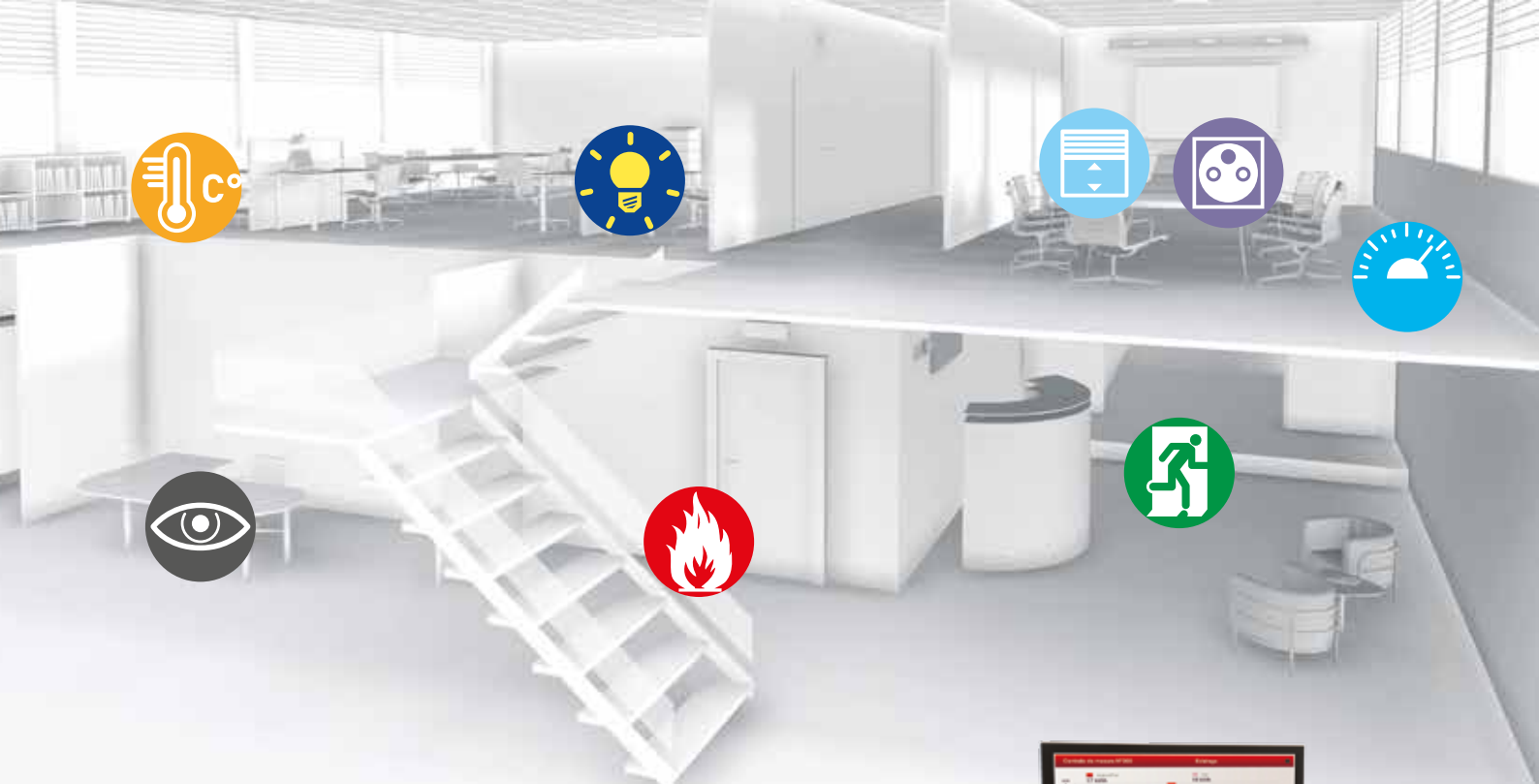

FIRE ALARM

ACCESS CONTROL,
CCTV, ...

PcVue Solutions



SCADA



IP MODBUS

gateway
modbus/IP

External solutions integrated in
the energy management system.



→ Active Energy Management | Load shedding equipment

Device Bus

GENERAL FEATURES

No more blackouts

The My Home load control management system manages the maximum power used, by automatically disconnecting the least important appliances in case of overload.

The system:

- Manages up to 63 loads
- Displays the instantaneous consumption and the cumulative consumption of the controlled phase on an hourly, daily and monthly basis on the display interfaces (e.g. Local Display, Energy base display, Touch Screen and Webserver). In addition, thanks to the actuator with sensor, it is possible to measure the actual consumption of the controlled load. - - It gives the possibility of disabling or re-enabling, using the display interfaces, the priorities configured based on the changed needs of the customer
- It gives the possibility of checking on the display interfaces the correct operation of the load using the measurement of the earth leakage current absorbed by the same. Dedicated icon on the Touch screen screen
- Its devices (central unit and actuators) only require the space of one DIN module. This ensure optimisation of spaces inside the distribution boards
- By configuring the actuators of the load control system in automation mode, it is possible to use display interfaces to set the time delays for the activation of the loads at set times

GENERAL DIAGRAM

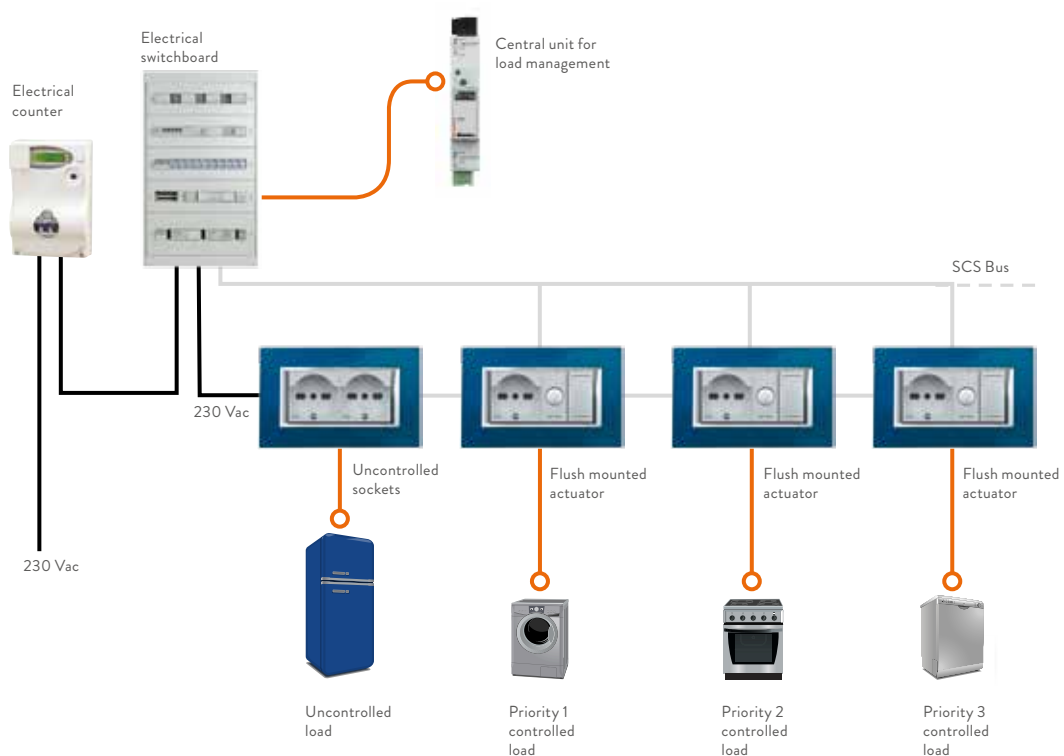

→ Active Energy Management | Load shedding equipment

Stand-alone device



GENERAL FEATURES

Arresters for 100% electrical system

- Constantly interrogate the total power consumption used and automatically exclude the non-priority circuits (e.g. convector heaters) if the limit of the contract with the energy supplier has been exceeded.
 - Distributing the consumptions means that a better contract can be agreed with the energy supplier.
-
- On average, for a 100 m² home with electrical heating, they allow reaching a saving of more than 40% per year on the contract
 - They avoid unwanted operation of the ERDF user circuit breaker
 - The arresters are connected directly downstream of the ERDF circuit breaker
 - Excluded circuit 15 A max
 - Above this value, use a power contactor
 - Possibility of forced exclusion
 - Display of the excluded circuits
-
- Single-phase arrester 230 V~ - 3 excluded circuits 15 A max. - incorporated coil
 - Three-phase arrester 400 V~ - 1 excluded circuit 15 A max. - incorporated coil
 - Three-phase arrester 400 V~ - 1 excluded circuit 15 A max. - incorporated coil

→ Active Energy Management

Lighting Management

COMBINES ENERGY EFFICIENCY, COMFORT AND OPERATING FLEXIBILITY

Did you know that lighting, with 24% energy consumption, ranks third in the power consumptions of a building, after heating and electricity? However, thanks to optimized management, you can now save up to 60% energy!

Make best use of daylight, adopt the appropriate solutions for each room and optimize the comfort of people and management flexibility; today these are the challenges to be faced in the construction and management of modern buildings.

For each project there are specific lighting management solutions: through concrete examples one can find the most suitable solution, to obtain energy efficiency and optimum comfort.

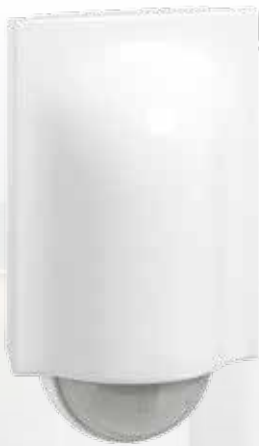

SAVINGS
60%

according to EN 15193



Our vision at Legrand is to provide products and services that make buildings more energy efficient.

We are committed to putting a stop to energy waste.

→ Active Energy Management | Lighting management

Lighting management in a building

OUR ANSWERS TO SEE CLEARLY

- **In a service-sector building, why distinguish between rooms with a contribution of natural light and rooms without a contribution of natural light?**

Rooms with a contribution of natural light require specific lighting, to improve the comfort of the people in them as a function of their activity and make best use of the natural light available. Rooms without a contribution of natural light are only lit artificially: as they are essentially walkways or small closed rooms, they can be managed completely automatically,

- **How to reduce the consumption of lighting in rooms without a contribution of natural light?**

It is a good idea to prefer basic movement sensors, which switch the lighting on automatically when a person passes by and switch it off when no movement is detected.

BASIC SENSORS

Managing lighting in rooms without a contribution of natural light

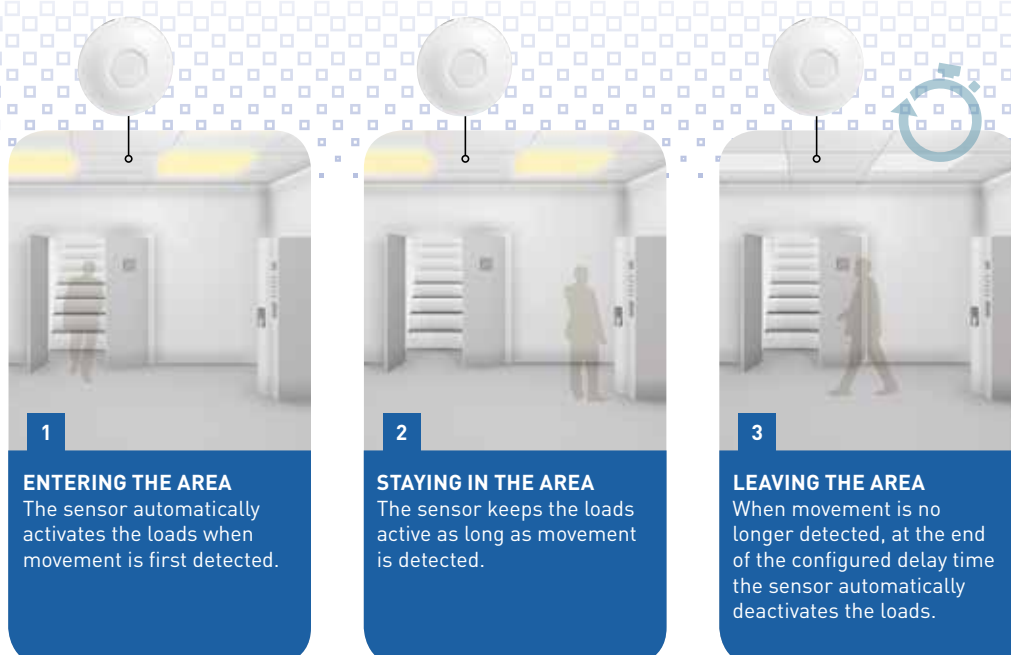

OUR ANSWERS TO SEE CLEARLY

- **How to reduce the power consumption of lighting in rooms with a contribution of natural light?**

In these rooms, when there are people and with a sufficient contribution of natural light, the lighting level must be switched off or reduced automatically.

It is therefore a good idea to prefer advanced presence and movement sensors, with integrated brightness cell, which check presence and brightness continuously.

- **How to activate or deactivate the lighting as you want, controlling energy consumption at the same time?**

A pushbutton can be associated to an advanced sensor, so that the lighting activates on purpose when you enter a room.

The sensor switches off automatically as soon as there is enough natural light, or immediately after the occupants have left the room. The pushbutton can allow you to activate, deactivate and dim the lighting manually at any time.

The ideal solution for all working spaces.



Advanced sensor



Manual control



Switching on on purpose and automatic switching off actively contribute to sustainable development



ADVANCED SENSORS

Managing lighting in rooms with a contribution of natural light

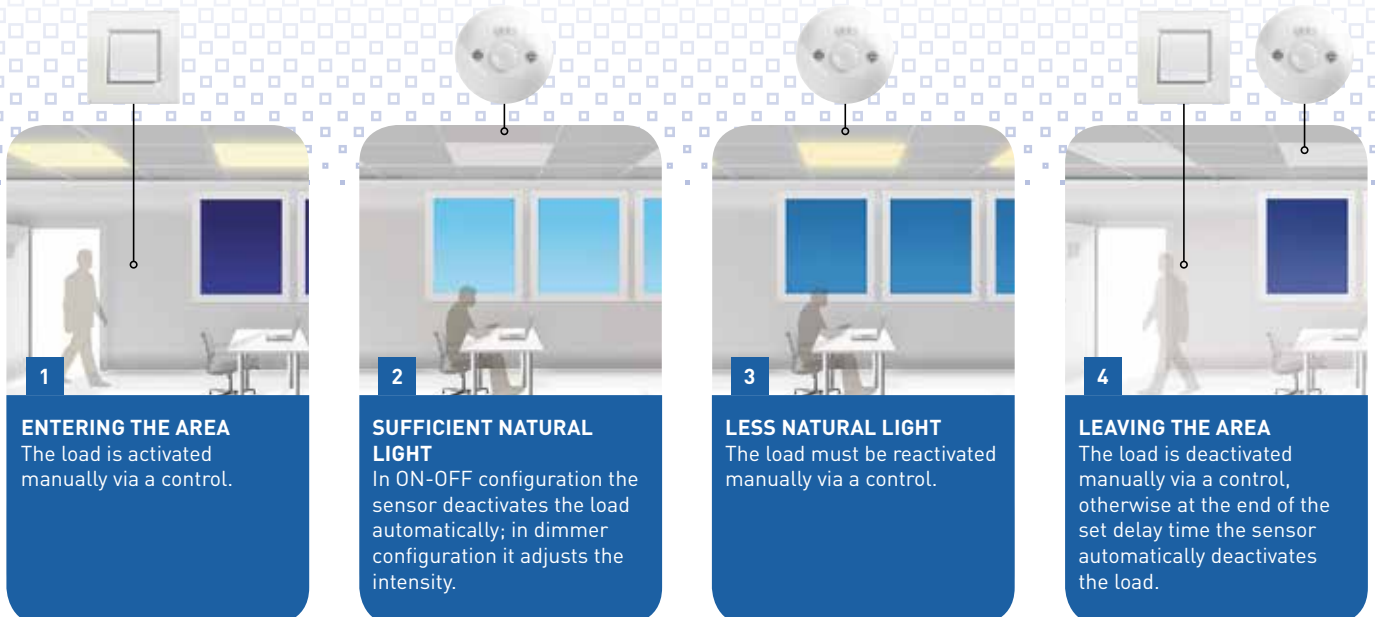



OUR ANSWERS TO SEE CLEARLY

- **Infrared or ultrasound detection: what is the difference?**

While infrared technology allows you to activate the lighting after considerable movements (e.g. walking) are detected, the combination of infrared and ultrasound also guarantees the identification of less perceptible movements.

- **Can the lighting intensity vary as a function of the natural light?**

Yes. Advanced sensors measure the contribution of natural light continuously.

Associated to particular controllers, they consequently adapt the lighting intensity.

The intensity can be different in the same room.



Double technology sensor: IR + ultrasound

ADVANCED SENSORS

Adjust the lighting in the rooms with a contribution of natural light

4

NATURAL LIGHT IS NOT DISTRIBUTED EQUALLY IN A ROOM
Each sensor is associated to a different area of the room (ideally a row of lights) to measure presence and brightness.
The dimmer controller adjusts each row of lights, integrating the external light and obtaining the necessary brightness.

OUR ANSWERS TO SEE CLEARLY

■ How to easily display, control and modify the adjustment of the advanced sensors?

BTicino proposes a remote configuration control which can interrogate at a distance and modify the sensor parameters preset in the factory:

- brightness threshold
- timing:
- mode of operation: automatic or manual switching on
- detection sensitivity

The remote control can display the parameters of each sensor:

- to modify them
- to save them and copy them on other sensors.



Mobile configuration remote control

■ Can lighting, rolling shutters and ventilation be controlled at the same time ... in the same room?

Yes. BTicino proposes a touch screen solution which allows you to run some preprogrammed scenarios with a simple gesture.

For example, in a meeting room, the “projection” scenario lowers the screen and the rolling shutters, reducing the lighting intensity at the same time.



Touch screen control

■ Can all the lighting of a building be managed?

Yes. BTicino – Legrand offer solutions which conform to the KNX world standard, which can display and manage all the lighting of a building.

Moreover, the combination of the KNX standard for control and DALI for lighting allows total flexibility: the rooms can be configured and reconfigured, without altering the wiring.



■ Can the lighting, automation and load control system of a building be controlled at the same time?

Yes. Supervision software and Building Manager allow active management of the building, displaying, managing and receiving alert messages and integrating various applications.



Legrand Supervision Software

→ Active Energy Management | Lighting management

Lighting management solution overview

BTicino offers a wide range of solutions for lighting management, suitable for any type of room and need. The proposal can be perfectly scaled so that you can always select the product which best answers your needs.

From the management of a single room and circuit to that of an entire building you can always find the correct answer for your needs.

The BTicino proposal summary table is given below.

ROOMS	Type of management	Local management			Global management
	Space to be checked	An area		More areas	
	Level of natural light	No	Yes		
	Number of circuits to be controlled	1 circuit	More circuits		
FUNCTIONS	Detection of: Movement	•	•	•	•
	Detection of: Movement + Presence	•	•	•	•
	Measurement of the lighting level	•	•	•	•
	Load management: On-Off	•	•	•	•
	Load management: Dimming		•	•	•
	Scenario management			•	•
	Supervision system				•
	Integration between different applications				•
SOLUTION		Switch Sensor	Switch Sensors or SCS sensors + Room controller	SCS + DIN sensors	KNX®
					

→ Active Energy Management | Lighting management

Buscom trunking...a unique power and data backbone

Buscom is at the heart of Electrak's lighting control solutions... distributing both power and communications within a single busbar trunking system, it provides a flexible and simple alternative to traditional wiring installations.



- Power and communication within a single trunking system
- Suitable for use with any lighting control protocol, including: KNX, LonWorks and DALI
- Modular, flexible system which is quick and simple to install and adapt
- Reduced potential points of failure in comparison with traditional wiring installations

THE HEART OF YOUR LIGHTING CONTROL SYSTEM

Installing a matrix of Buscom trunking in the ceiling void creates an accessible power and communications backbone throughout a building. The backbone can be tapped into at any point to facilitate instant connection to power and control circuits.

Buscom incorporates a shielded twisted pair communications bus inside each length and tap-off, and is suitable for use with any lighting control protocol, including: KNX, LonWorks and DALI.

MODULAR. FLEXIBLE. SIMPLE.

Trunking lengths simply push fit together, saving time and money on installation. With cable terminations only required for power and control circuits in the feed unit, Buscom delivers a plug and play solution that allows for future lighting layout changes to be made quickly and efficiently, whilst drastically reducing the potential points of failure in comparison with traditional wiring methods.

Buscom adds a new dimension to lighting busbar that extends the unquestionable plug and play advantages from the power circuit to the control circuit. This unique system for distributing lighting control signals delivers unrivalled flexibility, regardless of the location of the intelligence...



INTELLIGENCE IN THE PANEL

Lighting control modules located in a central cabinet are connected to the Buscom system via communication circuits that terminate in the feed unit. Control signals are then distributed along the trunking run and made available at any tap-off outlet.



INTELLIGENCE IN THE BUSBAR

Integrating lighting control technology into the Buscom feed unit is particularly effective for DALI control. Each trunking run converts to an individual DALI network into which luminaires can tap-in at any point.

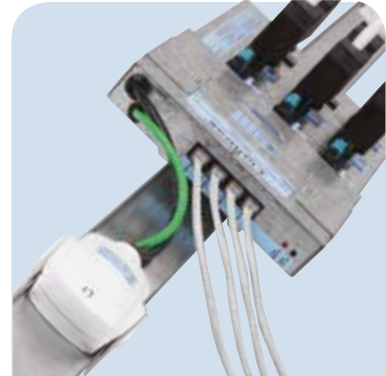

INTELLIGENCE IN THE LCU

Lighting central units (LCUs) are mounted onto and plugged into Buscom trunking, providing a hub into which multiples of luminaires and switching devices are plugged. Buscom's integrated communication bus provides the backbone which networks all control devices together.

ENERGY SAVING



As with all Electrak solutions, **Buscom is a modular system designed to be quick and simple to install, reducing man hours and energy usage on site.**

KNX is approved as:

- European Standard (CENELEC EN 50090 and CEN EN 13321-1)
- International Standard (ISO/IEC 14543-3)

→ Active Energy Management | Lighting management

The ability to adapt with the building throughout its life

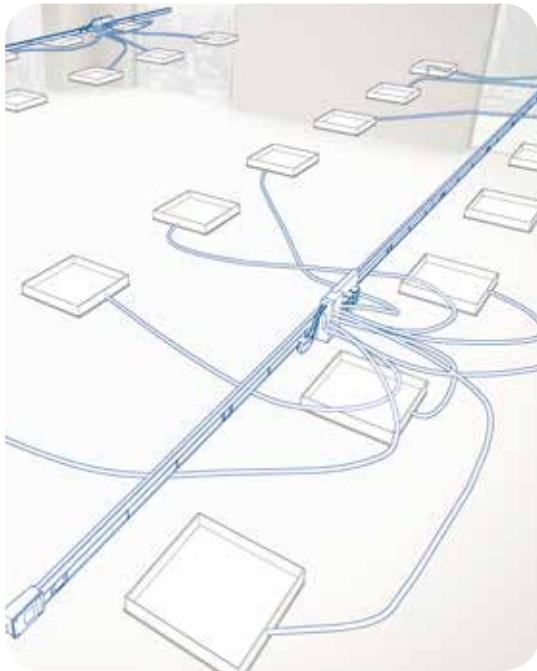

At the Category A stage of an office fit-out the lighting requirements of the final tenant are not known.

With Buscom, developers are able to install a cost-effective lighting control solution that is adequate for the client attraction phase, but can be upgraded to meet the needs of the incoming tenant with a minimum level of investment in time and labour.

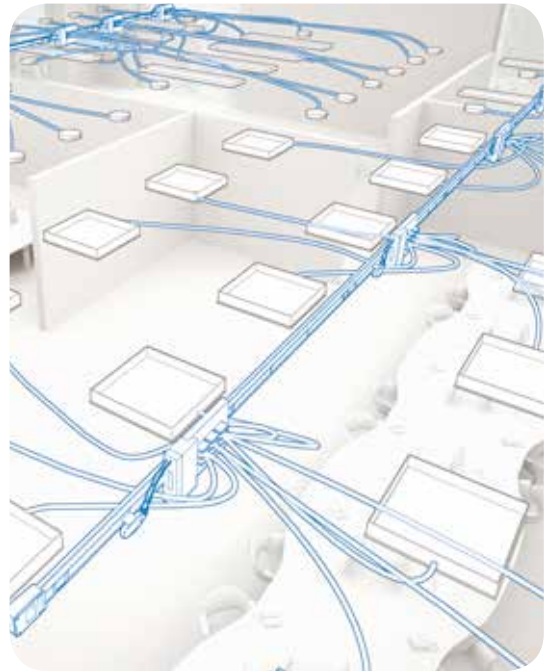

With a matrix of Buscom trunking installed, a Lightrak installation provides a future proof solution where lighting schemes can be completely reconfigured without the need to run or terminate any additional cables.

Lighting central units are simply unplugged, moved and reprogrammed; additional devices and central units can also be added to extend the capability of any installation.



→ Active Energy Management | Lighting management

Buscom, seamless integration with your technology of choice

The Buscom system operates over a KNX backbone. This enables all control devices connected to the system to communicate with each other, and facilitates seamless interoperability with any KNX certified product.

KNX PROTOCOL SYSTEMS

KNX is the worldwide standard for all applications in home and building control, ranging from lighting and shutter control to security, HVAC, metering and energy management. With close to 300 members and approximately 7000 certified product ranges, the KNX Association holds partnership agreements with over 30,000 installer companies in over 100 countries.

All products bearing the KNX logo are certified in order to guarantee system compatibility, interworking and interoperability and are commissioned via a single, manufacturer independent design and commissioning tool.

KNX was used as the underlying technology at Terminal 5, Heathrow... possibly the largest lighting control installation in Europe.

ENERGY SAVING



Lighting accounts for up to 40% of a commercial building's electricity use.
(Lighting Industry Federation)

Lighting controls can provide energy savings of 30% to 55%.

→ Active Energy Management | Lighting management

LB Plus Data in the Lighting management

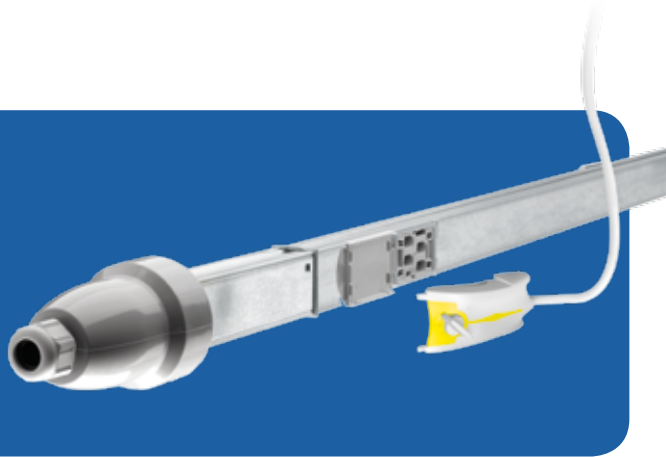

LB PLUS DATA THE NEW BUSBAR TRUNKING FOR LIGHTING MANAGEMENT

The management of artificial light in modern systems is an essential element to ensure both better comfort and energy savings, with consequent reduction of operating costs. It is with these 2 objectives in mind that the

system LB PLUS DATA was conceived, the new busbar trunking system with an internal BUS that can be used for the management of DALI or 1-10V protocol based lighting.

Lb Plus is the range of busbars for lighting and energy distribution from 25 to 63 A. Extremely flexible, with 10, 16 and 25 A tap-off plugs, it allows to adapt the system to any development.

The **LbPlus Data** version has a BUS inside which makes the busbar the ideal solution for efficient lighting management in service-sector rooms.

All the **LbPlus accessories** are common to both busbar versions. The protection index is IP 55 and the protection index against mechanical impact is IK 07

FLEXIBILITY AND SAFETY

Reconfiguring a system using the LB PLUS DATA solution is easy, quick, and safe. The construction characteristics ensure that whenever it is necessary to combine energy distribution with lighting management, LB PLUS DATA is the optimum solution.

MAXIMUM FLEXIBILITY OF USE

The certified protocols that can be used with LB PLUS DATA are the DALI and the 1-10V protocols.

NEW DEDICATED PLUGS

LB PLUS DATA has new plugs for drawing energy and for the connection of the BUS. With these new plugs, power and data signals can be drawn with one operation.

The tap-off plugs, identified by the yellow colour, are dedicated for the data signal.

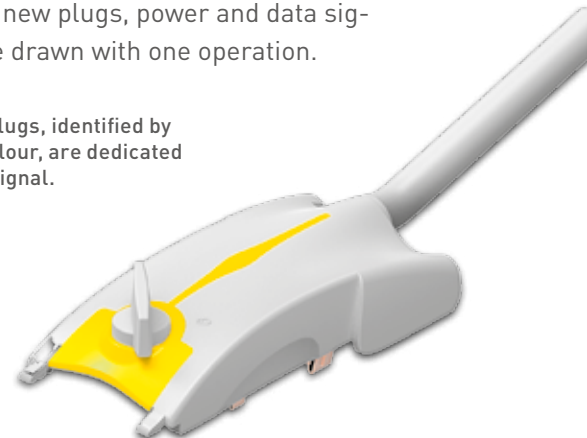

→ Active Energy Management | Lighting management

The savings achievable with LB Plus Data

INSTALLATION EXAMPLE

Below is an example of a practical application of LB PLUS DATA, with indications of the possible savings. The area of reference is a galvanic treatment area which is part of a plant of approximately 400 sqm, with skylights fitted on the roof.

GALVANIC TREATMENT AREA LAYOUT

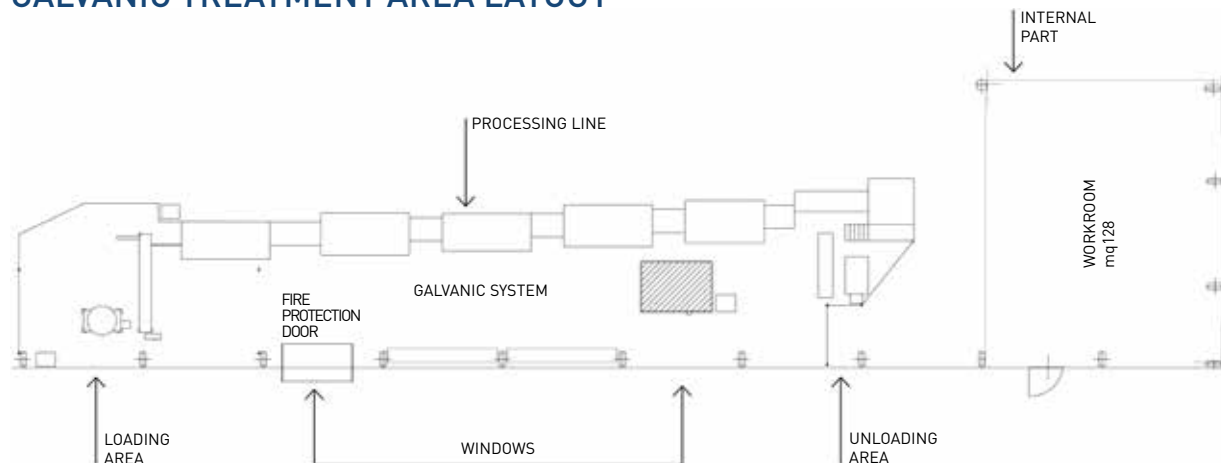

MAIN DESIGN DATA

- Lighting system: 3 rows of 18 lamps each. Each row is made up of 2 fluorescent tubes 80W each. Total installed power: 6.3 KW.
- Control system: lamps controlled by DALI ballast and connected in groups of 9 to the KNX/DALI interface, for total of 6 groups of 9 lamps each, and each of them is connected to a different interface output.
- Type of management: DALI broadcast: each of the 9 lamps in each group is fully automatically controlled on the basis of movement detection and the contribution of natural light detected by the KNX sensors.

MAIN OPERATING DATA

- Working days per year: 240
- Operating hours per day: 16 (in two shifts)
- Operations carried out
Line load: twice a day; the whole line is illuminated for approximately 2h.
Line unload: four times a day; the unloading line is illuminated for approximately 0.5h.
Production: the whole line is off

EXAMPLE OF INSTALLATION DIAGRAM

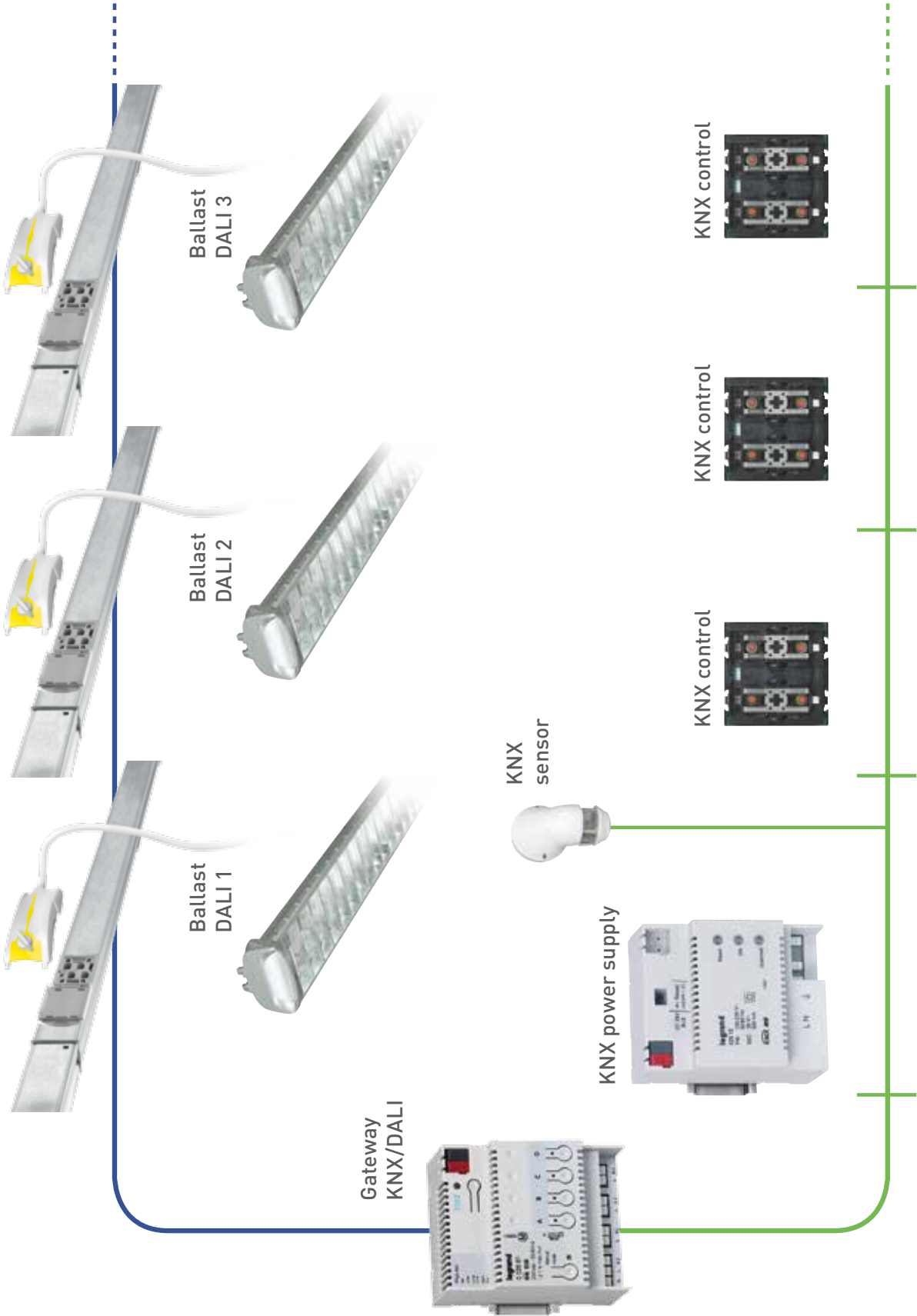

— KNX BUS
— DALI BUS

The DALI BUS is integrated in the LB PLUS DATA busbar trunking, while the KNX BUS is outside the busbar trunking. The lamps receive the supply and the DALI signal through the dedicated plug. All the other KNX devices are connected directly to the KNX BUS, and are installed on the board, or wherever necessary around the department.

The data on energy consumption and savings that can be obtained are valid for the installation example, using the same number and the same size loads, with the type of control described, and complying with the types and times of operation described.

TYPE OF CONTROL SOLUTION	TOTAL ELECTRICITY CONSUMED IN ONE YEAR (KWH/Y)	TOTAL ELECTRICITY SAVINGS IN ONE YEAR
LB Plus without control*	19,043	-
LB Plus DATA with control KNX/DALI broadcast	8,268	57%



By further refining the management possibilities, the implementation of an addressed DALI control solution makes it possible to further maximize savings, reaching up to 61%.

For the details of the project contact the commercial representative of reference.

NOTE

*MAIN OPERATING DATA

- Working days per year: 240
- Operations carried out:
Light fully On 8h/day * 20 days/month during 5 months + Light fully On 16h/day * 20 days/month during 7 months



→ Active Energy Management | Lighting management

A new management of the lighting

The Sarlam Chartres ceiling lights have been renewed to offer you the new LED reference range: Chartres Infini. A combination of technologies and new functions, with an ultra-flat design. And there is still more.

Thanks to a synergy of know-how, Chartres Infini fits into a complete lighting system. Associated with the Legrand detection, control and lighting management products, the latest product of the Sarlam range immerses you in a new experience, that of simplicity, reliability, saving and efficiency.

Discover our lighting solutions and offer your park a complete answer to your needs and expectations, from installation to management, from comfort to the serenity of the users.



COSTS UNDER CONTROL

Chartres Infini ceiling lights offer you the opportunity to monitor costs and reduce building expenses thanks to quality lighting which only comes on when needed.

LIGHT BETTER, CONSUME LESS:
LED AND DETECTION, THE EFFICIENT DUO.

A RELIABLE ANSWER

NF certified and CEE eligible (BAR-EQ-110, for the detection models only) the Chartres Infini ceiling lights give an answer to the latest standards and the Accessibility decree, for optimum safety and efficiency.



EVERLASTING ASSETS

Chartres Infini ceiling lights are durable. They have LED technology which guarantees: reliability, long-life, quality lighting and reduced maintenance, without lamp replacement. They can be programmed quickly via the remote configuration tool. And the same centre distance common to all the Chartres products allows you to replace the device park really simply.

→ Active Energy Management | Lighting management

Chartres Infini has everything you need

Design, performance and reliability. Why choose? Chartres Infini offers you everything, without compromise: the best lighting, thanks to a new-generation LED ceiling light.

2 SIZES

SIZE 1 : DIAMETER 31 CM
SIZE 2: DIAMETER 43.5 CM

POWER

FROM 1000 TO 4000 LUMEN

THE MOST POWERFUL
CEILING LIGHT
ON THE MARKET

COMPOSITION OF

DIFFUSER AND BODY IN
POLYCARBONATE

LED TECHNOLOGY

UP TO 50 000
OPERATING HOURS

THICKNESS

FROM 69 MM THICKNESS

EXTRA FLAT DESIGN

3 FINISHES

METAL GREY,
WHITE,
ANTHRACITE



- **Anti-vandal and reinforced anti-vandal version**
Resists the most hostile environments.
- **Protection index**
IP 55 / IK 10 +



FUNCTIONS



ON / OFF

The ceiling light only lights up when it is powered. It is operated by an external control, such as a circuit breaker or a sensor.



DOUBLE LEVEL/TIMING

The ceiling light has two separate functions:

- Double level: it allows two lighting levels (adjustable with the configuration tool) which can be controlled from two external control points (a circuit breaker and a pushbutton)
- Timer: the ceiling light lights up with an external pushbutton for a programmable length of time



HF DETECTION

The ceiling light is always supplied on the network and only lights up when the following conditions are satisfied: presence of a person and insufficient brightness. These ceiling lights have a going-out warning and a stand-by function. An auxiliary input allows switching from one mode of operation 1 to another mode of operation 2.



HF DETECTION + CLOCK

The features of these ceiling lights are identical to those of HF detection ceiling lights. They also have the capacity of planning switching in extended mode (switching from a mode of operation 1 to a mode of operation 2) by means of the incorporated clock. This clock can be programmed with the configuration tool.

NEW GENERATION CONFIGURATION



PREPARE YOUR SITE IN ADVANCE TO GAIN TIME!

Chartres Infini with NFC* chip.
Thanks to the “Close Up” application, you can configure your Chartres Infini ceiling lights from your Smartphone even before they are wired or supplied.

*Near Field Communication

THE EFFECTIVE CONFIGURATION FOR A SIGNIFICANT TIME SAVING

Thanks to the configuration tool, the Chartres Infini ceiling light can be configured in a few minutes without having to disassemble it. You can:

- modify the factory parameters to import the program suitable for the environment and the users
- interrogate the ceiling light on the adjustments and send it new parameters, to adjust the lighting scenario at any time
- duplicate configuration programs from one ceiling light to another to obtain an identical configuration in record time



SIMPLE AND QUICK PROGRAMMING

→ Active Energy Management | Lighting management

Controlling any light source, any building, any space

ENERGY IS A LIMITED RESOURCE

Around 20% of the world's electricity is used for lighting. Much of it is wasted. Unoccupied offices, factories and public spaces often remain brightly lit, squandering money and energy. It's bad for the bottom line – and the environment. Yet there is a solution.

INNOVATION AND QUALITY BAR NONE

At CP Electronics, we're making an international reputation for delivering energy saving controls. With our commitment to innovation, we hold a number of patents. We have a relentless focus on quality and reliability.

ANY LIGHT SOURCE, ANY BUILDING, ANY SPACE

From a sports stadium to a CEO's boardroom – we work with both private companies and public sector organisations. Our UK-based production team works to high quality standards, using advanced production techniques. We're so confident of our quality and testing regime that we offer a five-year warranty across the range. Our products are backed by dedicated sales, aftersales and technical support teams: on site, on the phone and online. The 2015 Paris Agreement focused the eyes of world leaders on climate change. But the reality is that wasting energy costs us all.

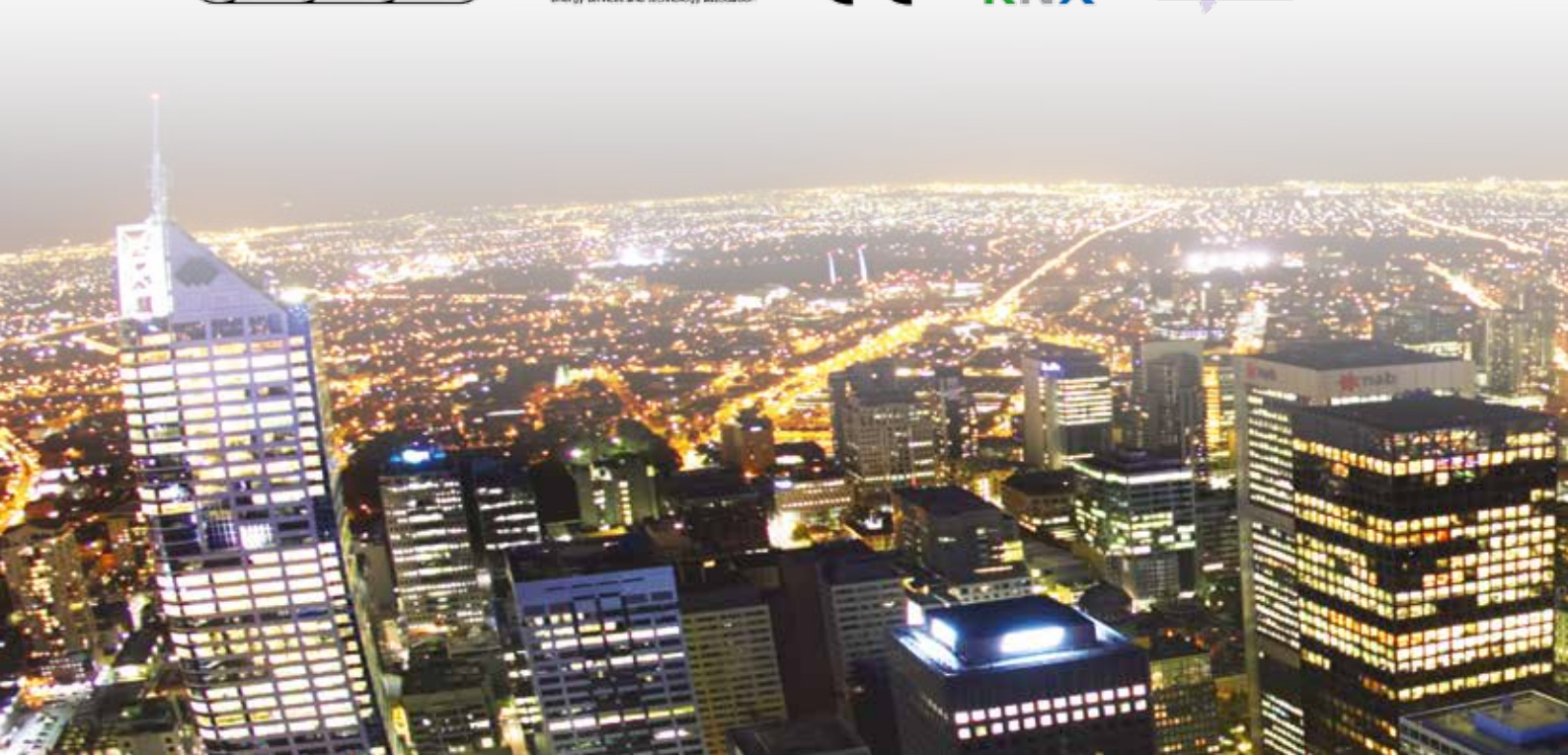

OUR BRANDS

Around 20% of the world's electricity is used for lighting. Much of it is wasted. Unoccupied offices, factories and public spaces often remain brightly lit, squandering money and energy. It's bad for the bottom line – and the environment. Yet there is a solution.



Our flagship range of programmable energy saving controls, systems and connection products for lighting, heating or ventilation.



Our off-the-shelf range of easy to fit energy saving controls and connection products for lighting, heating or ventilation.

RAPID

The fully addressable and networkable lighting control solution. RAPID works with multiple protocols such as DALI and DSI for seamless communication between switching devices.



An-10®

A robust range of wireless devices for a wide range of applications. An-10® has full scenario functionality and is programmable from an intuitive infrared handset.

VITESSE plus

Vitesse Plus is a seven-channel stand-alone lighting control system – it incorporates an inbuilt preset menu that makes configuration and maintenance quick and easy.



D-Mate® provides a cost effective four scenario setting system with all the benefits of energy saving control.

VITESSE modular

Vitesse Modular™ is a modular pluggable lighting connection solution that is available in switching and dimming variants.



→ Active Energy Management | Lighting management

PIR Presence Detectors

COMPACT (PIR) PASSIVE INFRARED PRESENCE DETECTORS, CEILING MOUNTING: EBDSPIR



- Switching, DALI and adjustment 0-10 V. (analogue)
- Presence detection
- Switching with light level sensor
- Attenuation-adjustment function
- Scenario setting and reset
- Constant brightness
- Control up to 20 ballasts

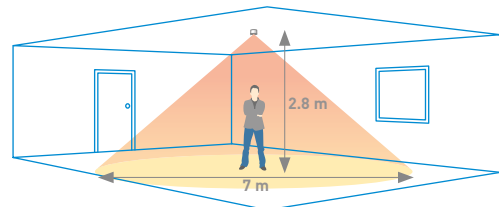

High < Sensitivity > Low

HIGH BAY (HIGH HEIGHTS) PIR PRESENCE DETECTORS: EBDHS



- Designed for Control at High Heights
- On/OFF, DALI and 0-10 V versions.
- Presence/absence detection
- Switching with light level sensor
- Attenuation function
- Scenario setting and reset
- Brightness adjustment
- Control up to 20 ballasts

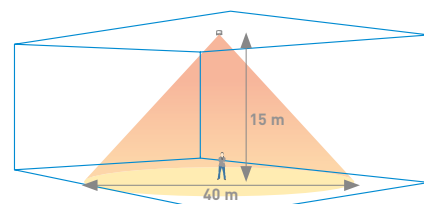

High < Sensitivity > Low

→ Active Energy Management | Lighting management

Microwave Presence Detectors

MICROWAVE PRESENCE DETECTOR WITH ADJUSTABLE HEAD: MWS3A



- ON/OFF, DALI and 0-10 V versions.
- Adjustable detection head
- Absence detection switching
- Adjustable detection sensitivity
- Programmable with IR remote control
- Integral relay to reduce parasitic power supply
- Photocell for brightness adjustment

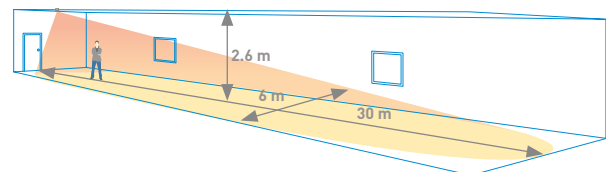

High < Sensitivity > Low

LOW PROFILE MICROWAVE PRESENCE DETECTOR: MWS6



- ON/OFF, DALI and 0-10 V versions.
- Adjustable detection sensitivity
- Programmable with IR remote control
- IP40
- Various regional frequencies
- Control up to 20 attenuation ballasts

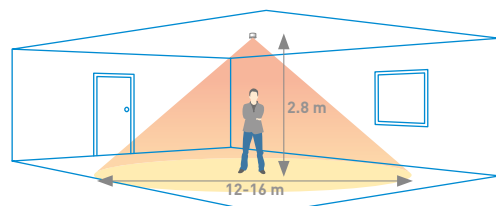

High < Sensitivity > Low

→ Active Energy Management | Lighting management

AN10 Wireless lighting control



Ballast controller in line

- DALI/DSI or 1–10 V ballast attenuation or switching control.
- Available for complete circuits or for integration in lighting devices.



Input unit with changeover switch

- Up to 7 inputs without voltage to be used with switching/standard or customized pushbutton cards.
- Simple preset configuration setting to select a typical scenario and up/down operation. Advanced configuration functions for the master cancellation selection, etc.
- Power supply: long-life internal battery or external 12 V supply.



Professional switching-on remote control (UNLCDHS)

- Easy programming; recording, saving and resetting settings with macro.

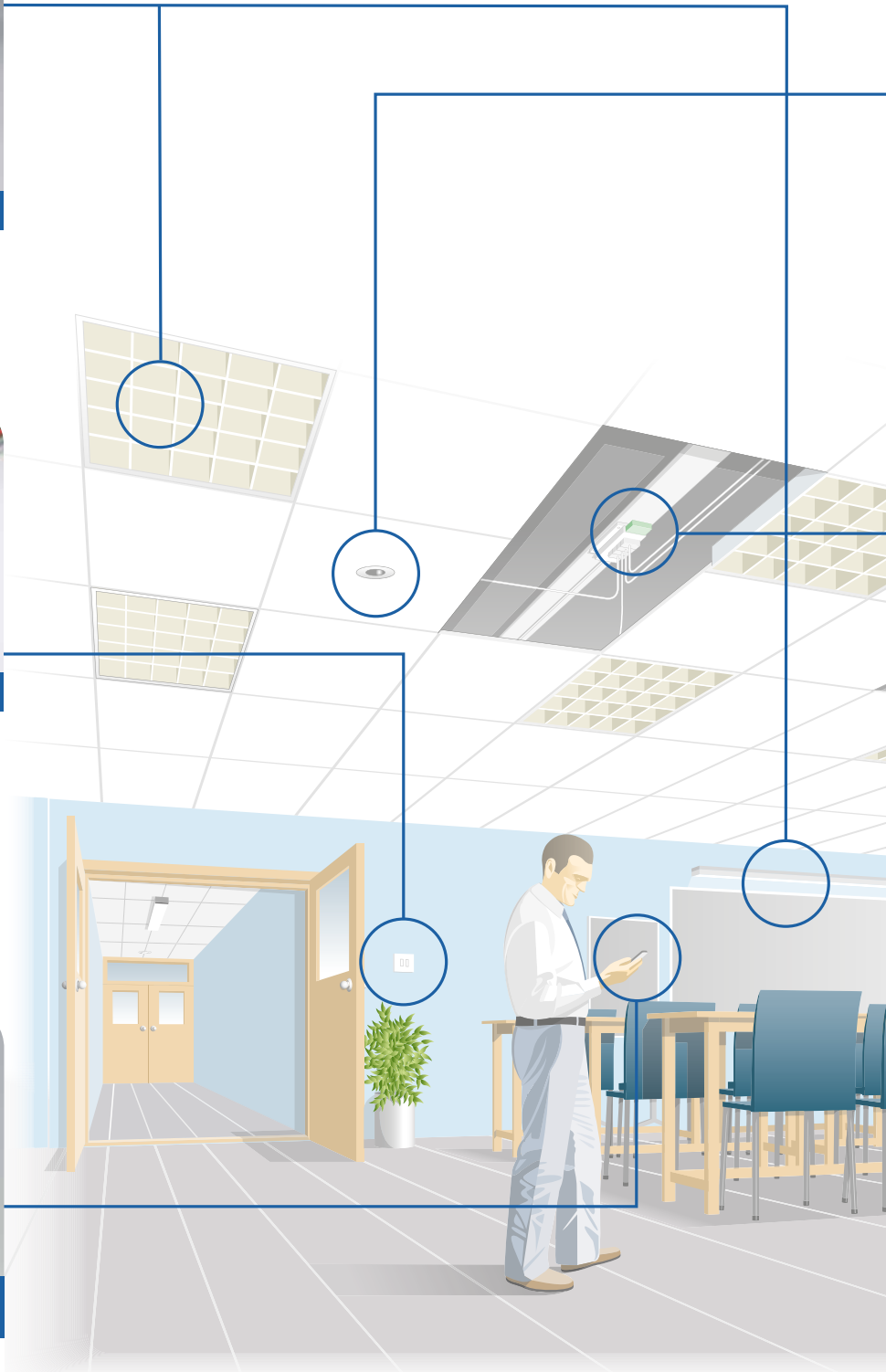

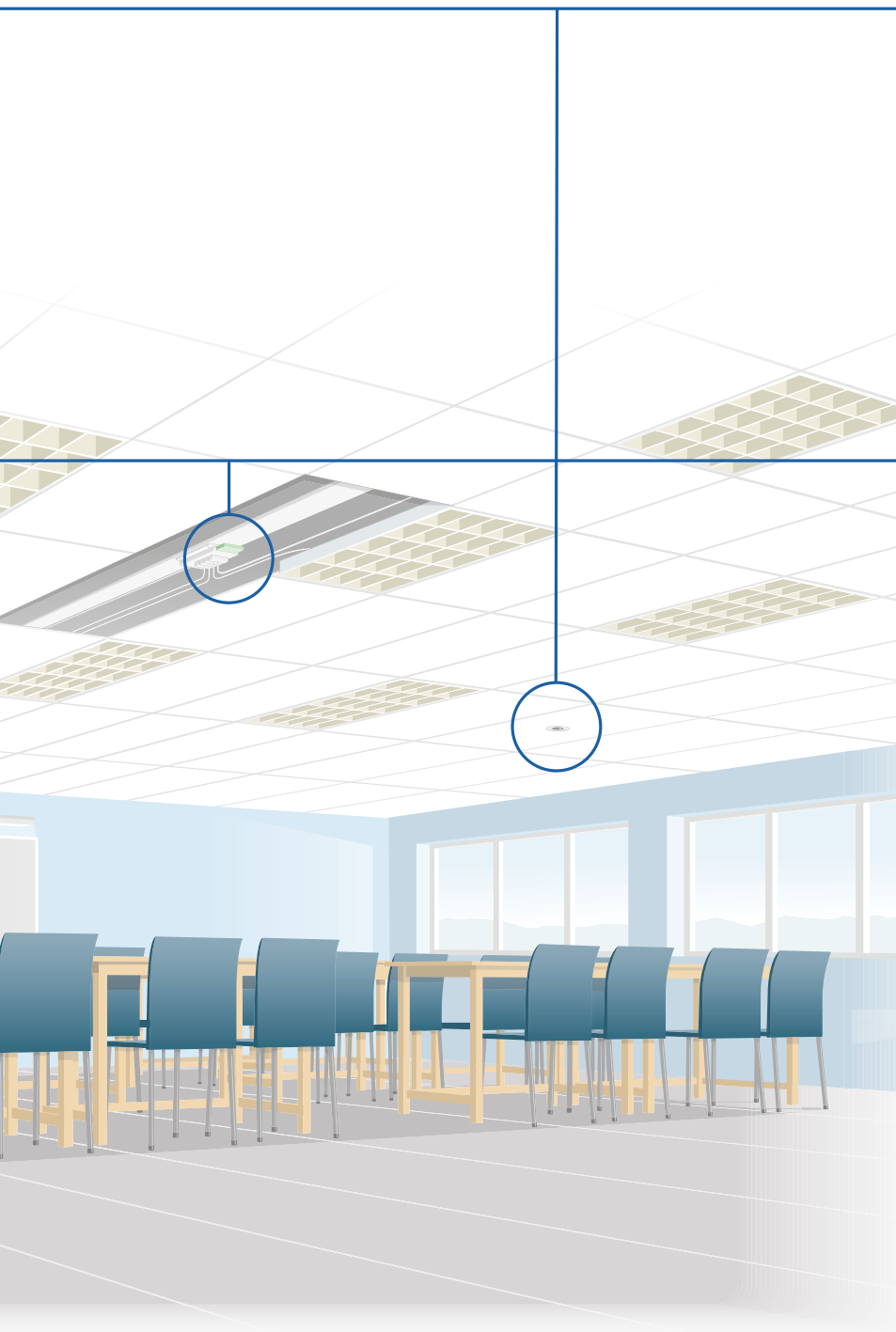

PIR and microwave presence detectors

- The An-10 presence and brightness detectors can also be used to control multiple outputs in other detectors, such as the An-10 controller ballast and the Vitesse Modular modules using a wireless system.



Vitesse Modular™ switching modules

- An-10 receiver to control the Vitesse Modular lighting connection system.
- Simple connection design, available in switching and attenuation versions.
- The system can be adapted easily depending on the changes of design and expansion.



RAPID - An-10 Gateway

- Allows integration between the An-10 control system and RAPID (Addressable Control system).

→ Active Energy Management | Lighting management

Rapid Fully Addressable Lighting Control System

Attenuation/switching devices

Switched, DSI/DALI or analogue transmission

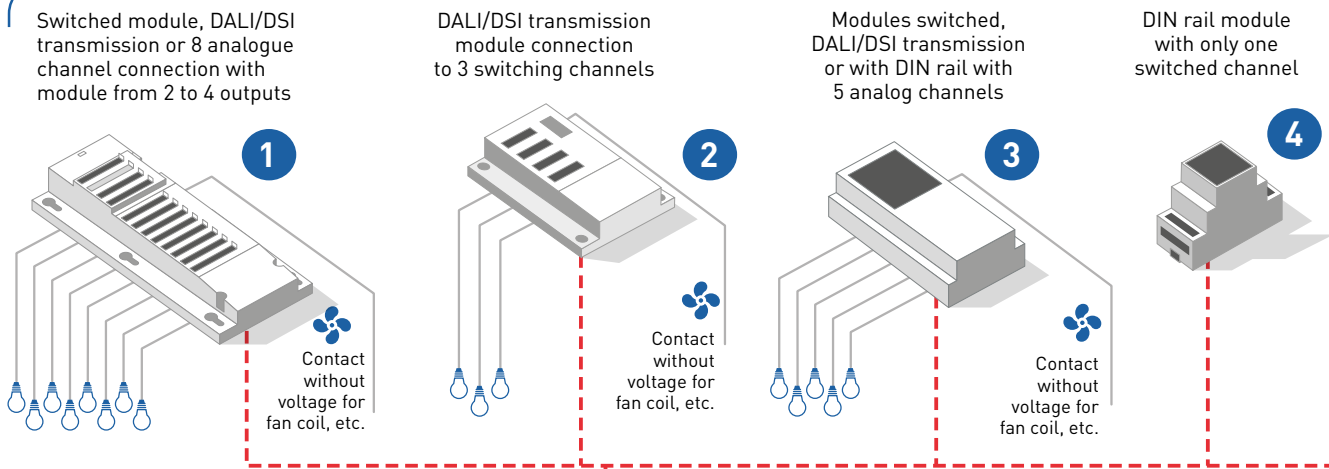

Area controller modules

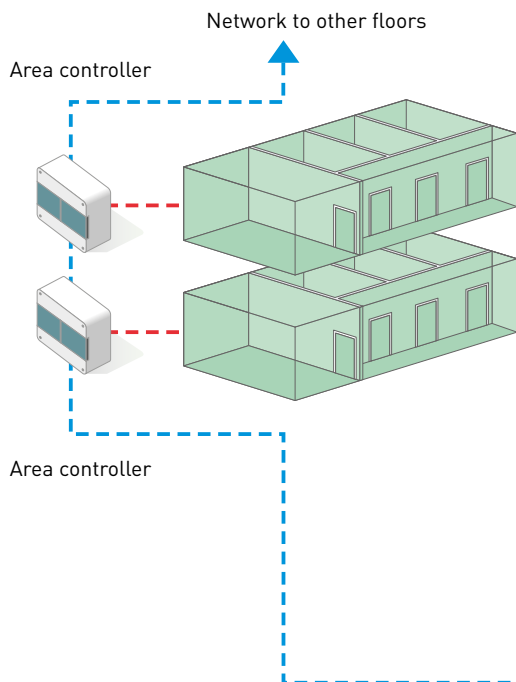

User interfaces

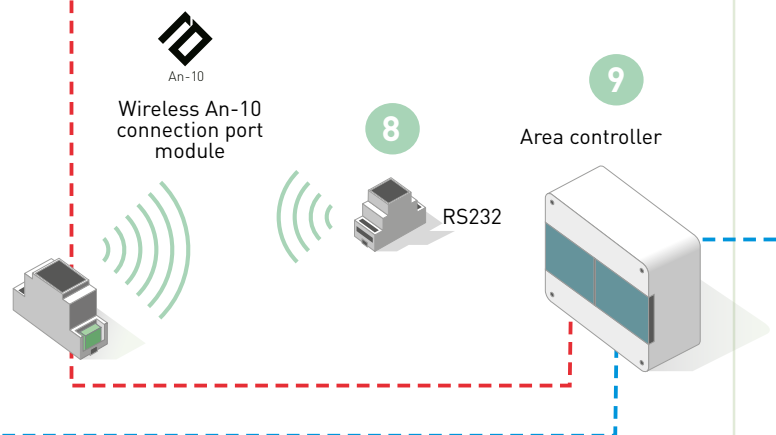

Our most advanced system. RAPID is a totally addressable solution, which can connect to the upper network and associate a state-of-the-art technology to a modular design.

It also has a graphic interface, easy to use. It makes possible the most demanding lighting control and energy management applications, without the costs and

complexity of other systems.

Combined with our energy detection technology (patented) RAPID is the complete lighting control solution.

Through our authorised retailers, we offer product design completely ready for use and the start-up service.

Addressable DALI

Compact module, switched or in line, for DALI/DSI transmission

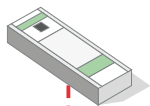

DALI switched and connectable module

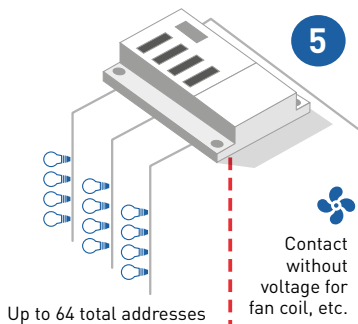

Switched module and with DIN DALI, LCM LMS rail

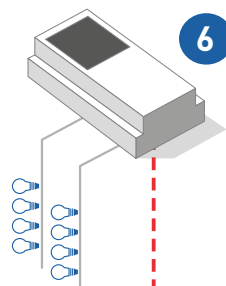

Addressable, in line and compact module

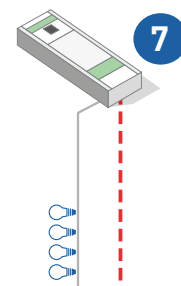

Mini PIR



PIR



Microwave



Mini PIR



PIR

Presence detectors

E
User reports

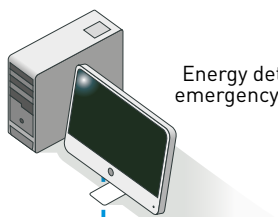

Energy detection and emergency monitoring

Connection port for open systems

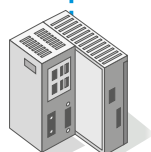

BACNET

Energy detection and emergency monitoring

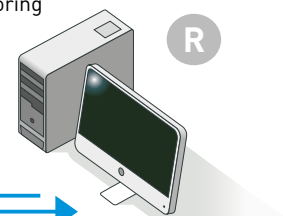

R

Remote monitoring (support/maintenance outside the systems).

Ratio creation and monitoring options



1 / EBR-LCM10-10DD

RAPID Lighting Control Module

- Expandable from 8 to 12 outputs
- Reduced installation cost for CatAcv
- Reduced expansion cost at CatB stage
- Mixed dimming and volt-free output options
- Energy Measurement



5 / EBR-LCM-DALIG64-B

Pluggable DALIG64 Lighting Control Module

- Up to 64 DALI addresses
- 11 ELV switch inputs
- IR handset and PC programmable
- Switching relay, ELT relay, Volt-free output
- Compatible with DALI emergency monitoring



2 / EBR-LCM3-1DD-B

3+1 channel LCM

- Three addressable individually dimmable outputs
- Additional switched output to control non-dimming devices
- Switching relay, ELT relay, Volt free output
- 11 SELV switch inputs
- DALI/DSI Broadcast



6 / EBR-DIN-DALIG64

Hardwired DALIG64 Module

- Up to 64 DALI addresses
- 8 ELV switch inputs
- 3 voltage free relay outputs
- Compatible with DALI emergency monitoring



3 / EBR-DIN-LCM5-5

5 Channel Hard Wired Lighting Control Module

- Individual addressing of outputs
- Adjustable off delays and group delays
- Adjustable start up lighting levels
- Scenario control for each channel

4 / Single Channel Module available



7 / EBR-MOD-DALIG

Compact In-Line DALI Gateway Module

- 10 individually addressable channels
- Control and fault feedback indication per channel
- Auto re-addressing of failed ballasts
- Power for up to 4 peripherals (PIR, Switch)
- Compatible with DALI emergency monitoring



8 / AR-DN-RS232

RS232 Module

- 2-way gateway to third party system
- Communication interface for AV systems
- Communication via third party system protocol
- IR or PC programmable (dongle required)



W / Presence Detection

- Passive Infrared (PIR)
- Microwave
- Mini PIR
- DALI addressable PIRs



9 / Area Controller

- 3 RAPID Bus networks
- Ethernet port – TCP/IP connectivity
- Time scheduled events
- Numerical keypad, with pass lock and 3 access levels
- Modular enclosure options available



E / EBR-CFE

Front End PC

- Reconfigure and/or monitor the status of control devices
- Reconfigure lighting groups via PC
- Emergency monitoring – lamp error feedback
- Energy Measurement



Q / EBR-4SC

- Up to 8 scenarios, plus a separate off scenario
- Adjustable fade rates up to 99 minutes per scenario
- Support for 99 individual circuits
- Up/down override
- Room divide input suitable for up to 3 interconnecting rooms



R / Energy Measurement

- Actual energy usage data
- For lighting measurement
- Measurement grouping – lighting, LCM, area, floor
- Real time reporting
- Web based reporting
- Off line reporting

→ Active Energy Management | Lighting management

LCM lighting control system

The simple preset settings allow you to configure and reconfigure the spaces quickly and easily. Vitesse Plus is a seven-channel lighting control system with a difference: it has an integrated preset settings menu which makes their configuration and maintenance easier. It offers an independent solution, ideal for a wide variety of applications.

MAIN FEATURES:

- 12 outputs
- 7 channels
- Level attenuation
- 4 x RJ45 inputs
- Scenario adjustment
- SELV switching inputs

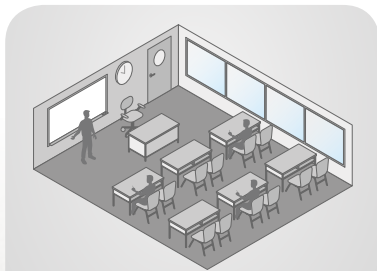

SERVICE SECTOR

Perfect independent system solution for small and medium-sized spaces.

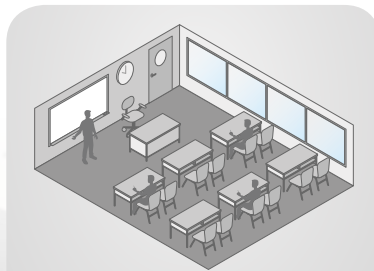

SALE TO RETAIL

Vitesse Plus is an adaptive and intuitive system, ideal for commercial sites. It offers total configuration flexibility.

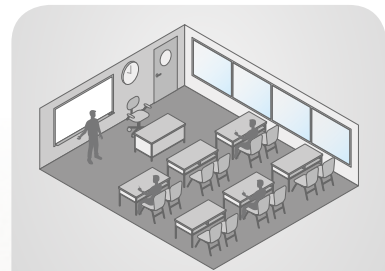

EDUCATION

The gradual adjustment and the setting of scenarios make the Vitesse Plus solution perfect in education areas.

Detector connector

Configuration flexibility

Connectors for 12 ranges of lighting devices

→ Active Energy Management

HVAC control

ZONE TEMPERATURE CONTROL: WHAT IS IT AND HOW DOES IT WORK?

A modern building must have an efficient heating and air conditioning system, which guarantees energy saving, while maintaining comfort for the occupants at the same time.

The BTicino zone temperature control system is a fundamental element which allows energy savings of up to 30%. By dividing the building into separately-controlled zones you can:

- manage the comfort temperature only when people are present
- manage the artificial heating or cooling only when it is really necessary, as a function of the contribution of solar irradiation

For example, in the cold season rooms exposed to solar irradiation require less energy for heating than those not exposed to the sun.



The cost decreases

By installing multi-zone systems you can obtain cost savings of up to 30% with respect to traditional systems with a single thermostat.

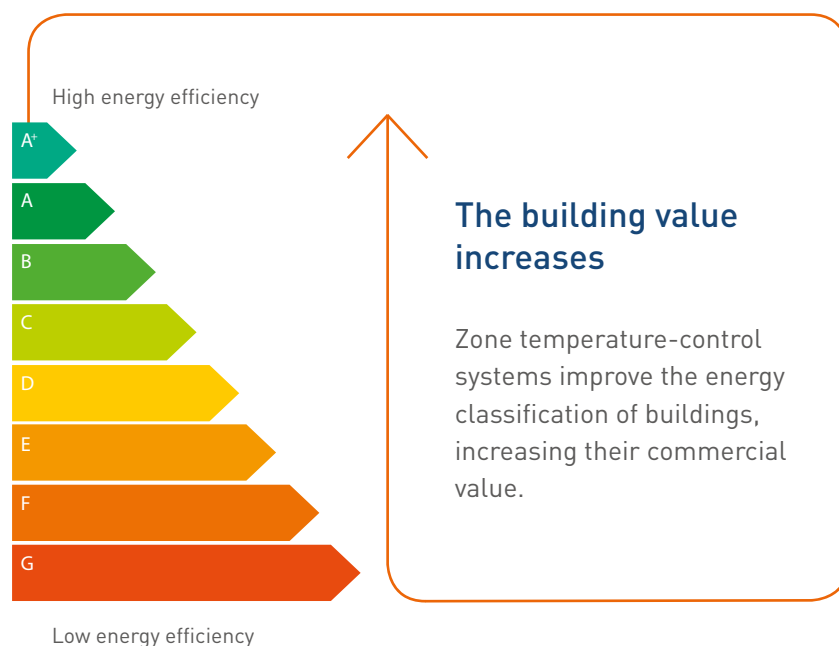

THE ADVANTAGES

- **Differentiate**
the temperature in relation to the room (bedroom, living room, office) and thus obtain "ideal" comfort on the basis of your needs and at the times you want.
- **Heat**
and cool exactly where and when needed avoiding waste and making maximum use of the sun's natural contribution.
- **Consequently reduce**
the energy consumption up to 30% with respect to single-zone systems.
- **Safeguard**
the room, thanks to the reduction of CO2 emissions in the air.
- **Improve**
the energy classification of the buildings.
- **Modify**
all the set parameters as and when you want in a few moments with maximum simplicity and from just one point (the central unit).

Without zone temperature control

The heating is working throughout the house and the rooms exposed to the sun are much hotter than the others.

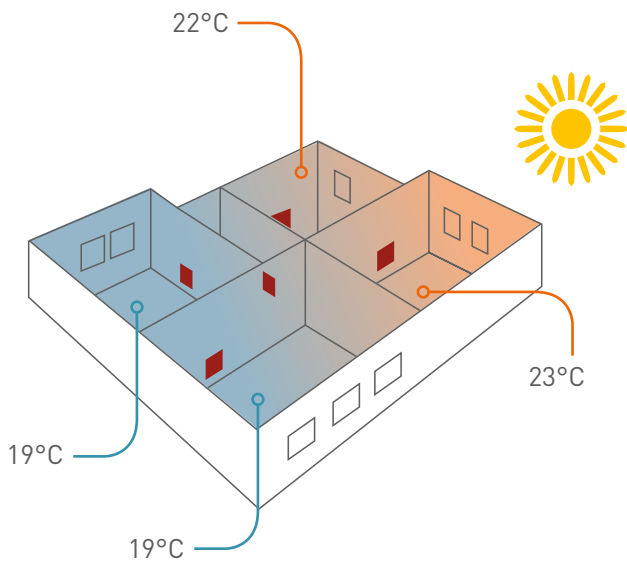

With zone temperature control

The heating is working throughout the house and the temperatures are regulated on the basis of real needs and solar irradiation.

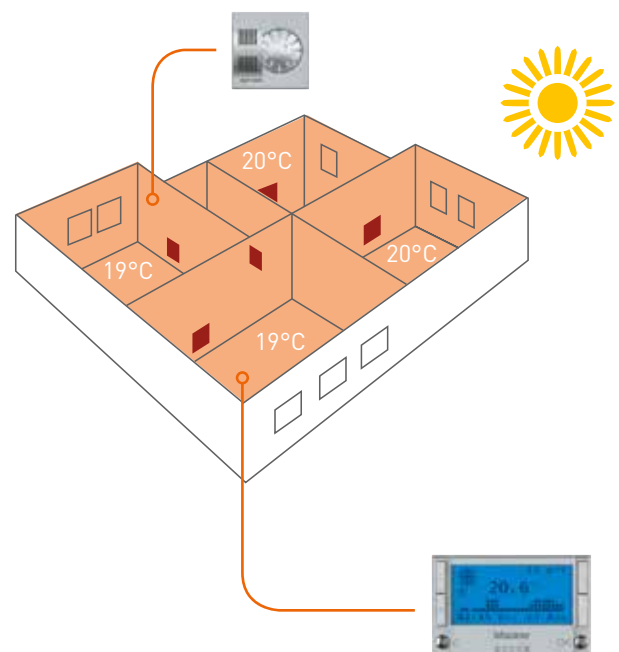

HOW DOES A ZONE TEMPERATURE-CONTROL SYSTEM WORK?

Operation is based on the central unit which receives the temperatures measured in the rooms or zones via the sensors.

Depending on the program set and the temperatures measured, the central unit controls the actuators which drive the opening and closing of the solenoid valves of each element (radiators, fan coils, radiant panels...).

In systems with master valves or circulation pumps actuators can be installed which control them as a function of programmed priority logics.

All the devices are connected together via an unshielded twisted pair bus wire, which transports both the signals and the 27 Vdc power contribution and which can be installed in the same piping as the traditional electrical system.

System with central unit up to 4 zones

The 4-zone central unit is the ideal solution for making systems in:

- apartments
- large and small houses even on several floors
- small shops and offices

With the temperature-control system you can build systems with up to 99 zones.

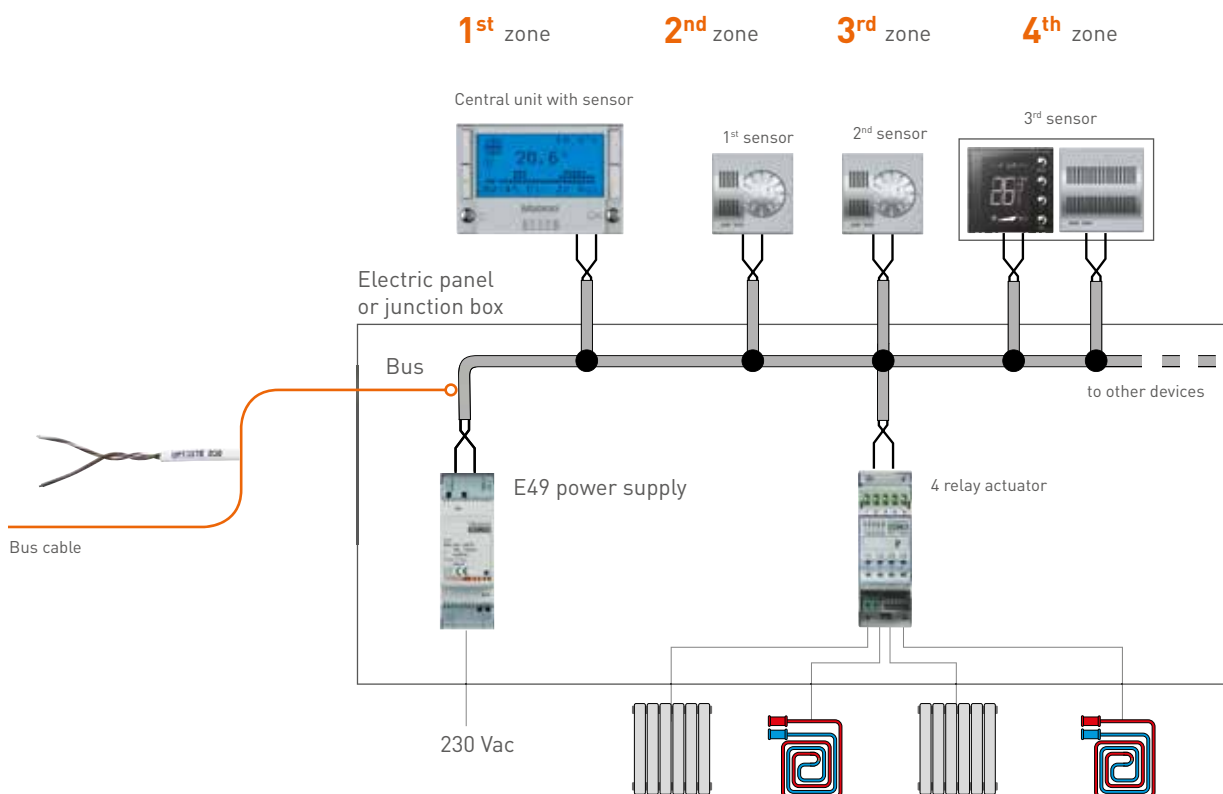

WHEN CAN IT BE INSTALLED?

A BTicino MY HOME zone system can be made when solenoid valves can be mounted on the hydraulic system collector to control the single hydraulic circuits.

System with central unit up to 99 zones

The 99-zone central unit is the ideal solution for making systems in:

- in residential contexts in large houses, apartment buildings and large buildings
- in the service sector in offices, shops, shopping centres and large banks

The 99-zone central unit can be controlled and managed remotely via Internet by means of the BTicino My Home Web portal.

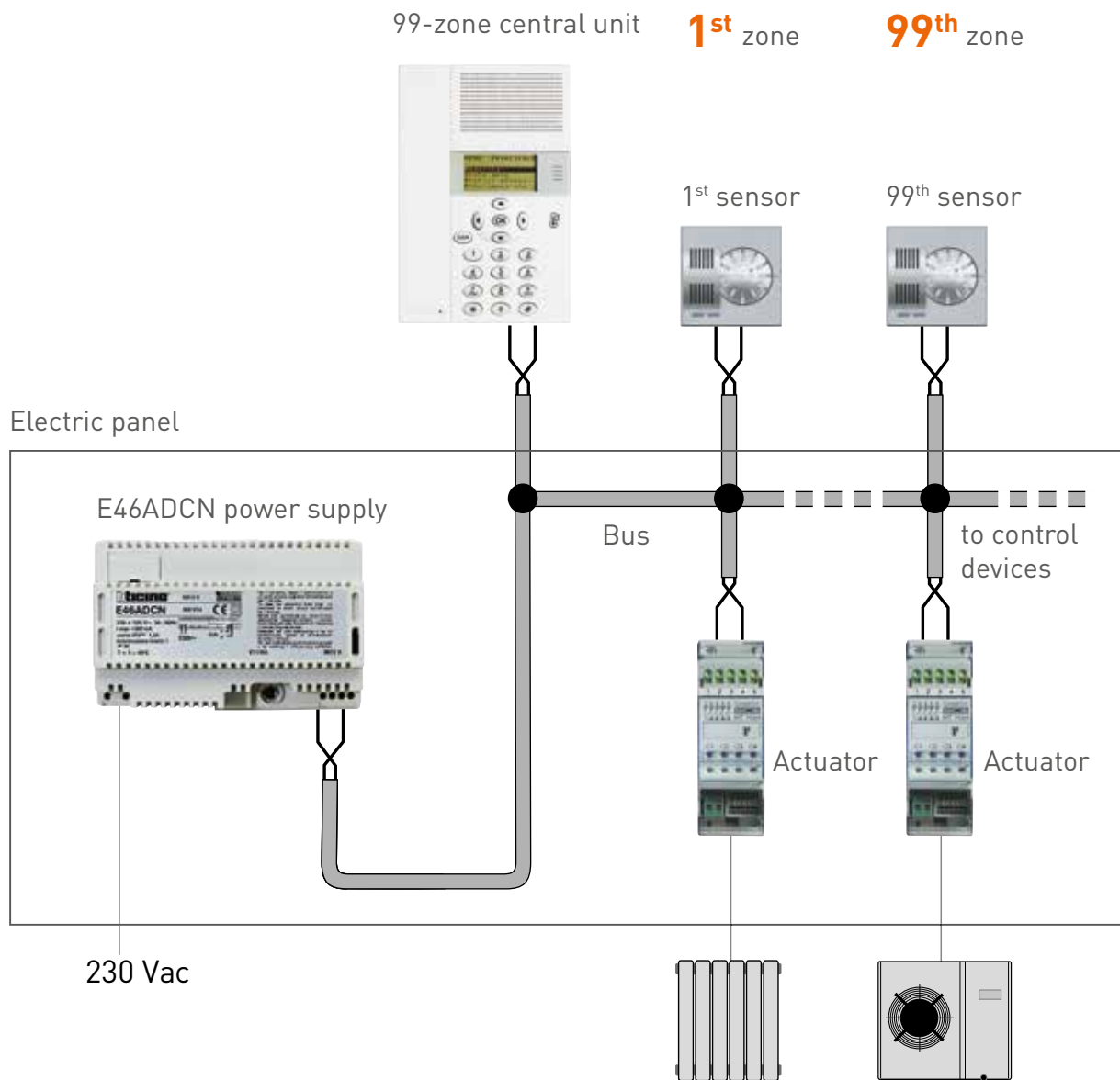

→ Active Energy Management

Time switch & Green socket



The time circuit breakers allow you to activate the loads only on certain days and times preestablished and programmed by the user. This also allows a reduction of electrical consumption and a cost saving.

The new AlphaRex³ circuit breakers allow even simpler management with their optimized resolution display and have the following features:

- Standard key for a simple and quick data transfer on other circuit breakers or for backup
- The technology of the time circuit breakers of the AlphaRex³ series guarantees exceptional performance, ideal for daily use
- The ease of programming allows you to obtain maximum time precision



The zero-crossing switching protects the contacts, extends the device's life and reduces costs and power consumption.

GREEN SOCKET

The green sockets are used in a system to identify the sockets where energy from renewable energy sources is used.



French standard (shown on 2 M cover plate)



German standard (shown on 3 M cover plate)



Italian standard (shown on 3 M cover plate)

→ Active Energy Management

Solar panel connections

A SOLUTION FOR PHOTOVOLTAIC SYSTEMS

The Legrand/BTicino solutions represent an answer to the widest application needs, from system start up to its connection to the low-voltage mains, always guaranteeing the maximum level of protection. The new proposal, practical and flexible, allows you to satisfy all residential and service requests, up to the large photovoltaic system.

Products:

- protection and isolation
- string boxes
- connection and wiring systems





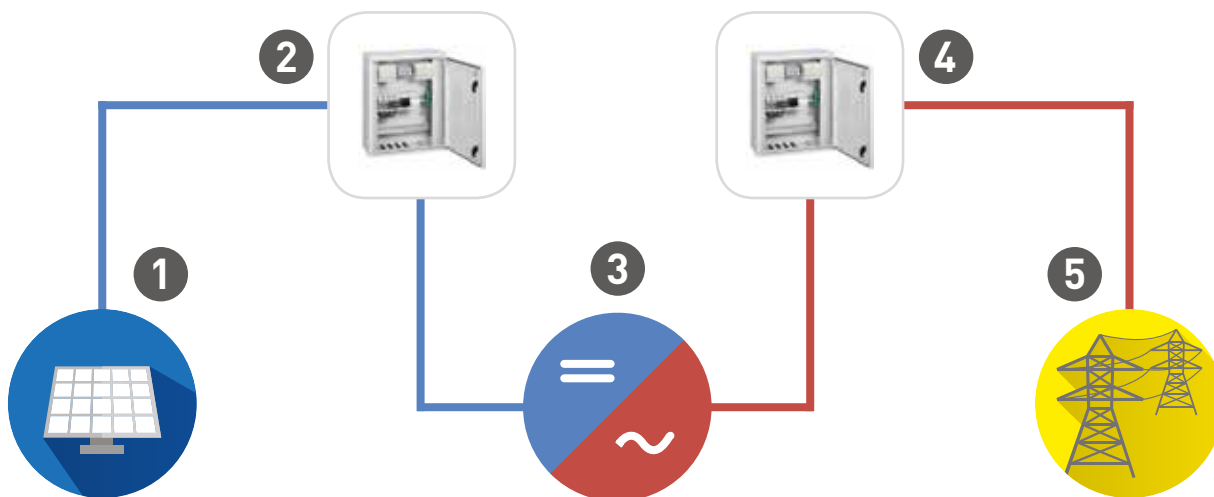

PRINCIPLE DIAGRAM

A photovoltaic system can convert light energy from the sun into electricity. The electricity generated by the solar cells is converted by an inverter to generate an alternating current compatible with the grid. Protections are necessary at different steps of the installations.



- 1 PV GENERATOR
- 2 SWITCHBOARDS ON DC SIDE
- 3 DC/AC STATIC CONVERTER (inverter)
- 4 SWITCHBOARD ON AC SIDE
- 5 DISTRIBUTOR NETWORK

-  DC CONNECTIONS
-  AC CONNECTIONS

A SOLUTION FOR PHOTOVOLTAIC SYSTEMS

With its complete range of proposals for the photovoltaic world, BTicino represents the reference point for applications in residential and service systems.

Designed to guarantee a simple and quick connection and start up, the proposal is complementary and perfectly integrated in traditional installations.

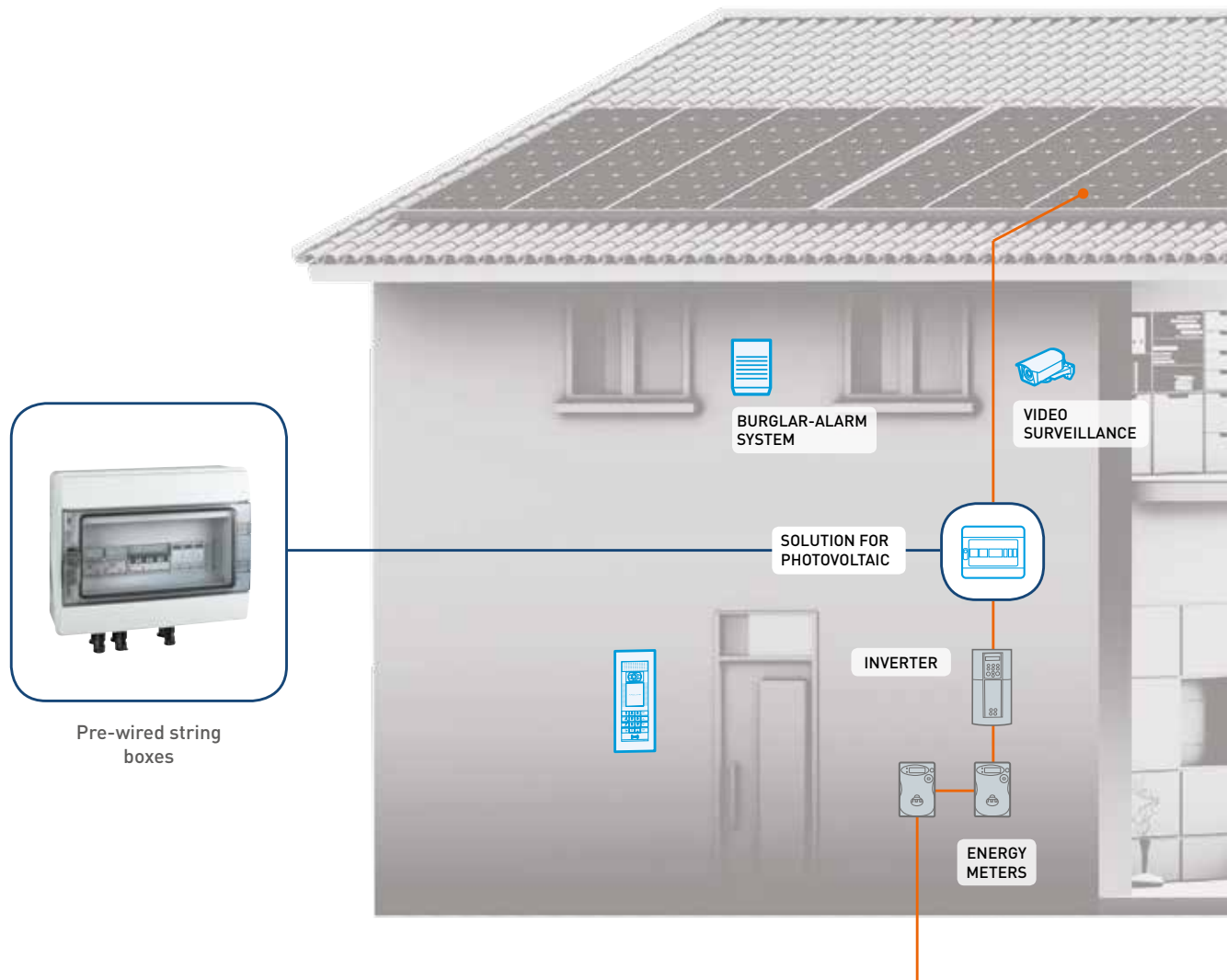

Pre-wired string boxes



Protection



Isolation



String boxes

MY HOME INTEGRATION

In design solutions using the MY HOME system you can measure the quantity of energy produced and keep it constantly under control.

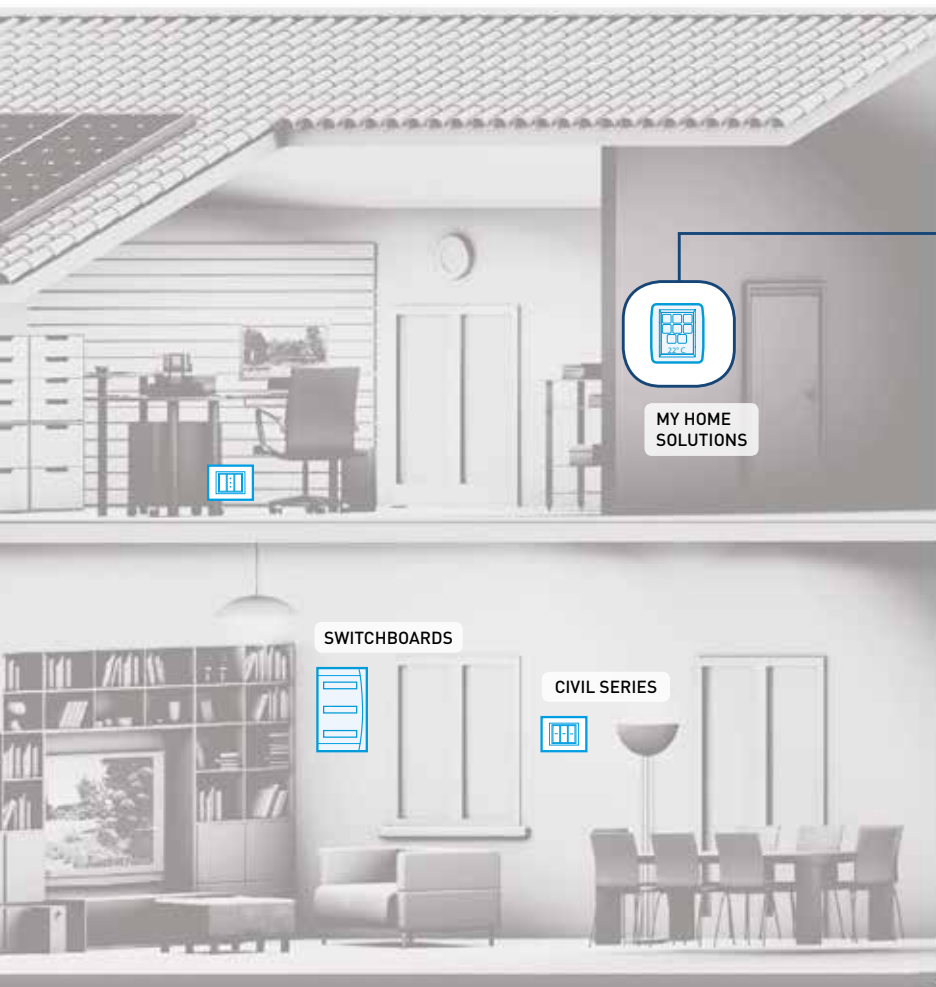

MY HOME SOLUTIONS

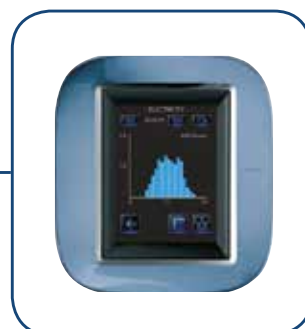

Touch screen to display the energy produced



Connection and wiring



Control and video surveillance

FOR PHOTOVOLTAIC SYSTEMS, FROM THE DC SIDE TO THE MAINS CONNECTION

With the Legrand/BTicino proposal you can satisfy the various connection and management requirements downstream of the generation of energy in the photovoltaic systems. The range is made up of systems for the transformation and transport of the energy and the containment of the equipment.

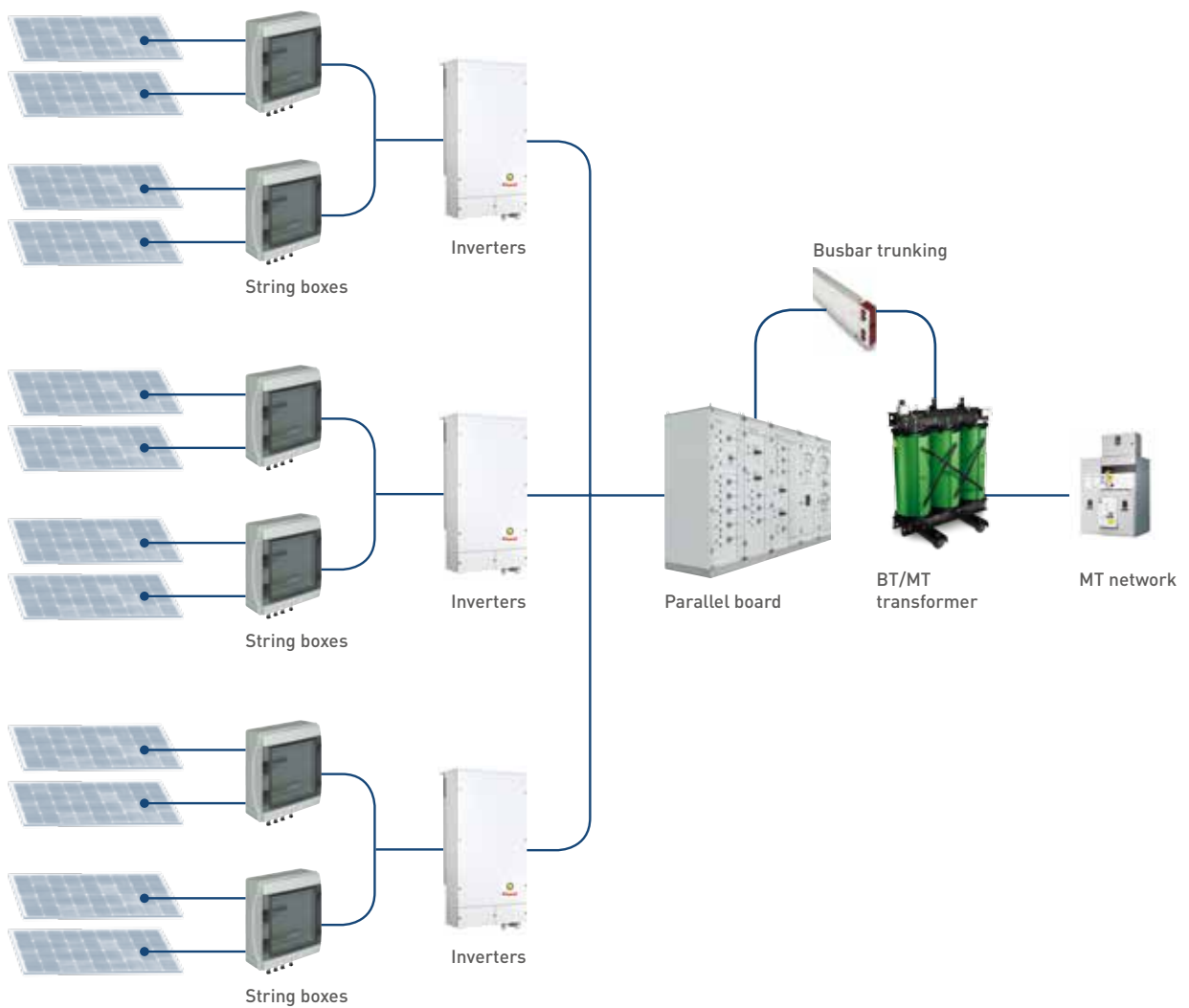

Parallel boards



Trunking distribution

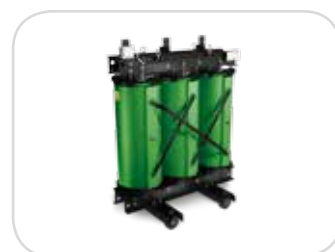

BT/MT transformers

→ Active Energy Management

Electrical vehicle Charging station

THE FUTURE OF TRANSPORT IS ELECTRICAL

DIRECTIVE 2014/94/UE OF THE EUROPEAN PARLIAMENT AND THE COUNCIL OF 22 OCTOBER 2014

The European directive establishes a common set of measures to make an infrastructure for alternative fuels in the Union, to minimize dependence on oil and attenuate the environmental impact in the transport sector. The member states guarantee the creation, by 31st December 2020, of an adequate number of charging points accessible to the public, to guarantee that electric vehicles circulate at least in urban/suburban agglomerates and in other densely populated zones.

NEW ENERGY FOR CARS

The motor industry and energy suppliers are turning their attention towards alternative mobility systems, which are less expensive for the user and which can reduce polluting emission. Electric vehicles are a very important answer to the lack of fossil fuels and excessive CO₂ emissions. A considerable increase in the sales of electric cars is expected in the future and consequently it will be fundamental to guarantee accessible energy which is available everywhere and at any time: at home, at work, on the road, in public car parks etc.

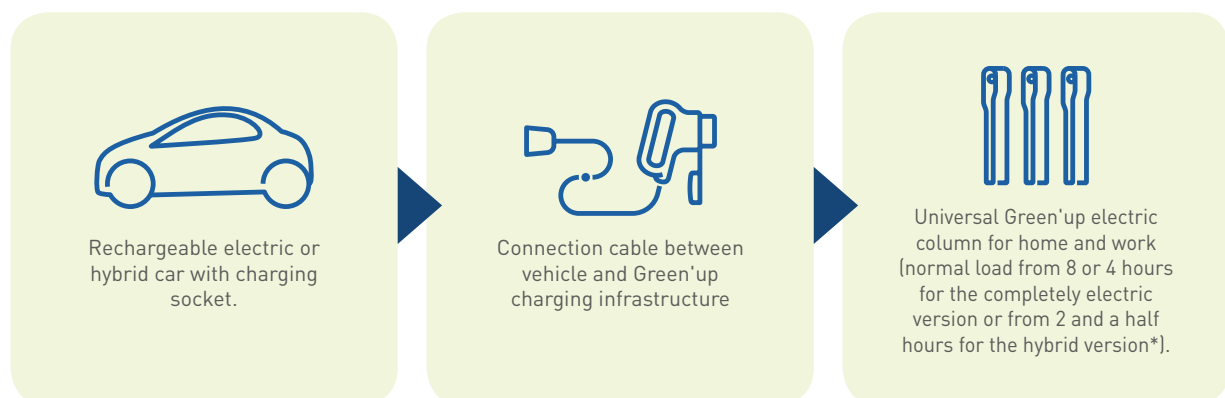

[*] Variable charging times depending on the versions

→ Active Energy Management | Electrical vehicle Charging station

Legrand GREEN'UP

Green'up is the Legrand system which allows the simple and safe charging of electric cars. The proposal is available in 2 different versions, depending on the performance required and how the electric vehicle is charged.

MODE 2

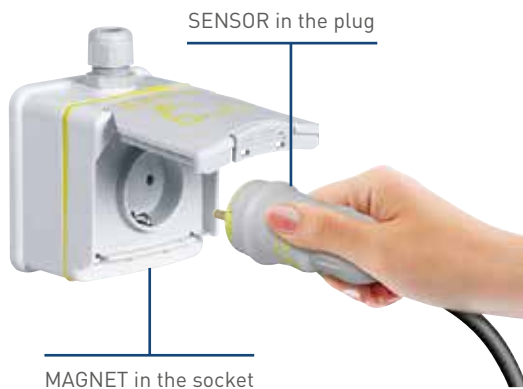

PATENTED
SYSTEM

Green'Up allows you to charge in MODE 2 via the cable which comes with the vehicle, supplying up to 16A⁽¹⁾ as compared to the 8A of a traditional German or French Standard socket.

When the plug is inserted in the socket the vehicle recognises that it is charging via Green'Up Access and enables a charge at higher current (16A), considerably reducing the charging time.

(1) For vehicles fitted with cable with Green'Up plug

MODE 3



BTicino offers the GREEN'UP PREMIUM charging station for MODE 3 charging

Safer and with better performance and suitable for any model of vehicle, the Green'Up Premium station supplies up to **32A three-phase** and guarantees a complete vehicle charge in just **1 hour**.



IEC 61851-1 is the reference standard for the electric vehicle conductive charging system. It defines the type of installation and the features of the charging infrastructure for electric vehicles.

According to IEC 61851-1 there are 4 possible recharge modes:

- **MODE 1**
slow charging only in the home (6 – 8 h), only in private environments and with a maximum current of 16A
- **MODE 2**
slow charging in the home (6 – 8 h). There is a Control Box (PWM safety system) on the vehicle charging cable
- **MODE 3**
slow (6 – 8 h) or relatively fast (1 h) charging in domestic or public environments is the obligatory requirement for public environments; the charge can also be fast (32 A, 400 V) with PWM (pulse width modulation) safety system
- **MODE 4**
fast charging in public places (5 – 10 min) is the rapid direct current charge (up to 200 A, 400 V)

→ Active Energy Management | Electrical vehicle Charging station

GREEN'UP ACCESS socket (mode 2)



From 8 to 16 A of completely safe charge ⁽²⁾ or all electric vehicles with a cable for mode 1 or 2, independent of the quantity of power required by the vehicle.

Polycarbonate socket, designed for electric vehicles, but suitable for any application
Conforms to standard IEC 60884-1



Maximum safety

Surface treatment of the metal contacts, to improve the electrical conductivity.

MODES 1 AND 2

Charging time



16A

IP 55/66 - IK 10
16A - 3.7 kW
single-phase

DETECTION SYSTEM PATENTED BY LEGRAND

Green'Up Access infrastructure and selects the maximum power which can be supplied by the socket (thus reducing charging times).

COST-EFFECTIVE, ADAPTABLE, AND SAFE SOLUTION

With the Green'up Access socket, Legrand makes it really easy to charge vehicles at home.

Economical and simple to install, Green'up Access sockets can also be used for other purposes and allow you to charge your electric vehicle simply, quickly and safely.

(1) Average total charging time according to manufacturer sources, variable depending on the model

(2) For vehicles fitted with cable with Green'Up plug

→ Active Energy Management | Electrical vehicle Charging station

GREEN'UP PREMIUM station (mode 3)



Green'Up Access socket
Mode 1 and 2 charging, for all applications.

Green'Up premium (32 A) for floor installation

MODES 1 AND 2

Charging time



IP 55/66 - IK 10
3,7 kW single-phase

MODE 3

Charging time



IP 55 - IK 10
22 kW three-phase



For any model of electric vehicle
Protected 2S EV socket for MODE 3 charging, conforming to the European Directives and the needs of car manufacturers.

Control of the charging

Allows you to program the time the charging starts and can exclude vehicle charging if there is an overload, avoiding unfortunate interruptions of service.

ZUCCHINI MEDIUM POWER MS TRUNKING



In covered car parks or in garages they guarantee an ideal power distribution for electric car columns

Connection for Green'Up column

[1] Average total charging time according to manufacturer sources, variable depending on the model



6

Building Energy Management System

- Supervision Software

Supervision Software

For optimum supervision with complete simplicity, Legrand offers “Legrand supervision software” (LSS) which allows you to view and control the whole of a building very easily: the management of Legrand solutions is pre-configured; screens are generated automatically.



Lighting control and display: a global and detailed view of each zone



Consumption display with comparison



	LIGHTING, SHUTTERS, SOCKET OUTLETS	MEASUREMENT, STATUS REPORT & COMMAND
View and control	<ul style="list-style-type: none"> Lighting status: global view for each zone Presence of people Brightness level Socket and shutter status Socket, shutter, lighting supervision workstation control, for each zone Scheduling according to the calendar day/month/year 	<p>For each zone and circuit, and for each user, display:</p> <ul style="list-style-type: none"> the consumptions per day/month/year the comparison to previous periods details of electrical values
Receive alerts	<ul style="list-style-type: none"> Display of the system problems E.g. : communication loss Status change of lighting, shutters... 	<ul style="list-style-type: none"> Excessive consumption for the whole building

→ Supervision software

For active Building Management

To meet any need of customisation (screens, variables, equipment, etc.) the Legrand supervision software can be customized in order to create a tailor-made solution. Open to KNX, Modbus, DALI and also Bacnet protocols, it requires an integrator for its set-up.

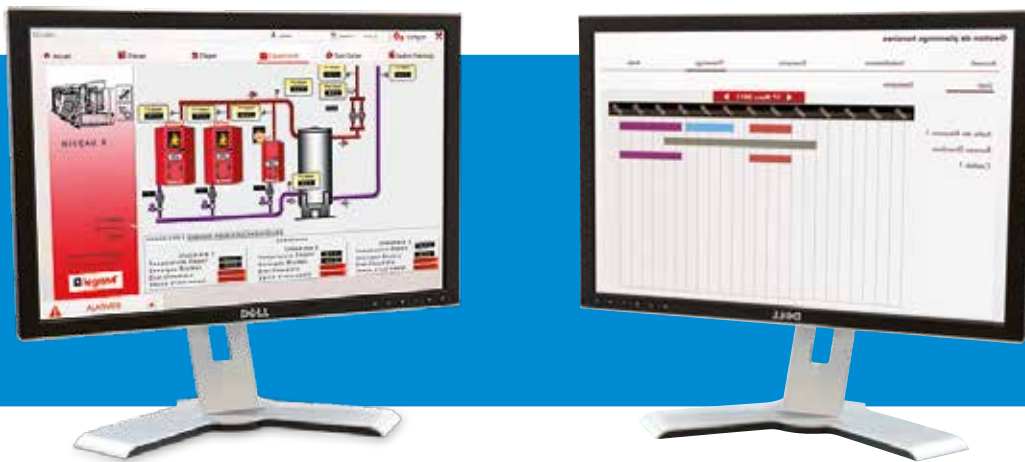

Customisable screens, with equipment shown on a plan

VIEW, CONTROL, RECEIVE ALERTS



Lighting

Operation mode management (comfort, eco...) depending on the room occupation periods, lighting duration display...



Safety lighting

Representation on a plan of the lighting block system



Measurement

Energy measurement, status report & command



CVC

Temperature adjustment, ventilation...
Display of the control synoptics



Access control

Monitoring of building activity

SOLUTIONS FOR THE BUILDING ACTIVE MANAGEMENT

VIEW, CONTROL, BE ALERTED

Ready for supervision for Legrand applications: lighting, safety lighting, measurement, fire alarm...



It allows a global management of the building

It works with:

- the measurement offer: with the RS 485/IP converter item 0 046 88, or with the communication modules item 0 146 76/78 associated to the measurement central unit item 0 146 69
- the BUS/KNX lighting offer, with the KNX/IP converter item 0 035 43
- the safety lighting offer with the addressable block management interface item 0 626 00

LEGRAND SUPERVISION SOFTWARE

Supervision software that allows the data display, the alarm management and analysis for service sector small projects:

- display of measurement values and connected system status
- alarm management console
- hourly programming

To be installed as resident on a dedicated PC

Integrated assisted mode to facilitate building of the project with display screens: preprogramming of the Legrand solutions (measurement of the consumptions of electricity, management of lighting, security lighting and fire alarms).

Expert mode to take account of third-party equipment (CVC) and customize display monitors

Pack	Item	
1	0 490 00	Ready to view, Up to 125 points
1	0 490 01	Ready to view, Up to 250 points
1	0 490 02	Ready to view, Up to 500 points
1	0 490 03	Ready to view, Up to 1000 points
1	0 490 04	Ready to view, Up to 2000 points

System architecture

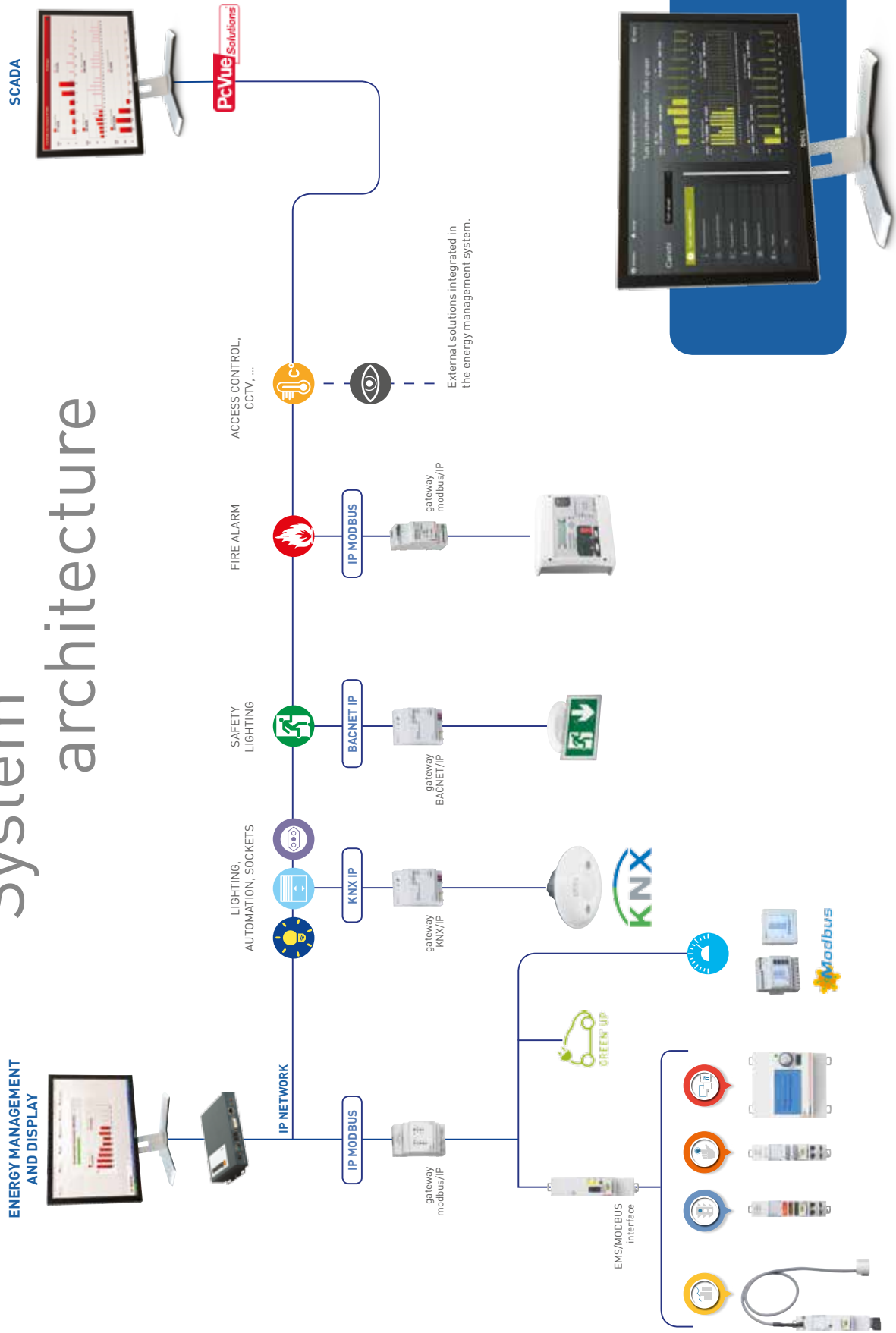



7

Typical application examples

- Residential sector
- Service sector
- Industry

→ Residential sector

Management of the cold and/or hot temperature in a home

NEED

Making a temperature-control system (heating and cooling) which allows me to manage and adjust different temperatures in different zones of the home (apartment, small home, large home, ...)



SOLUTION/PROJECT

Thanks to the “Zone temperature-control” system and dividing the building into separately-controlled zones you can: manage the comfort temperature only when people are present and manage the artificial heating or cooling only when it is really necessary, depending on the contribution of solar irradiation.

For example, in the cold season rooms exposed to solar irradiation require less energy for heating than those not exposed to the sun.

System with central unit up to 4 zones

The 4-zone central unit is the ideal solution for making systems in:

- apartments
- large and small houses even on several floors
- small shops and offices

With the temperature-control system you can build systems with up to 99 zones.

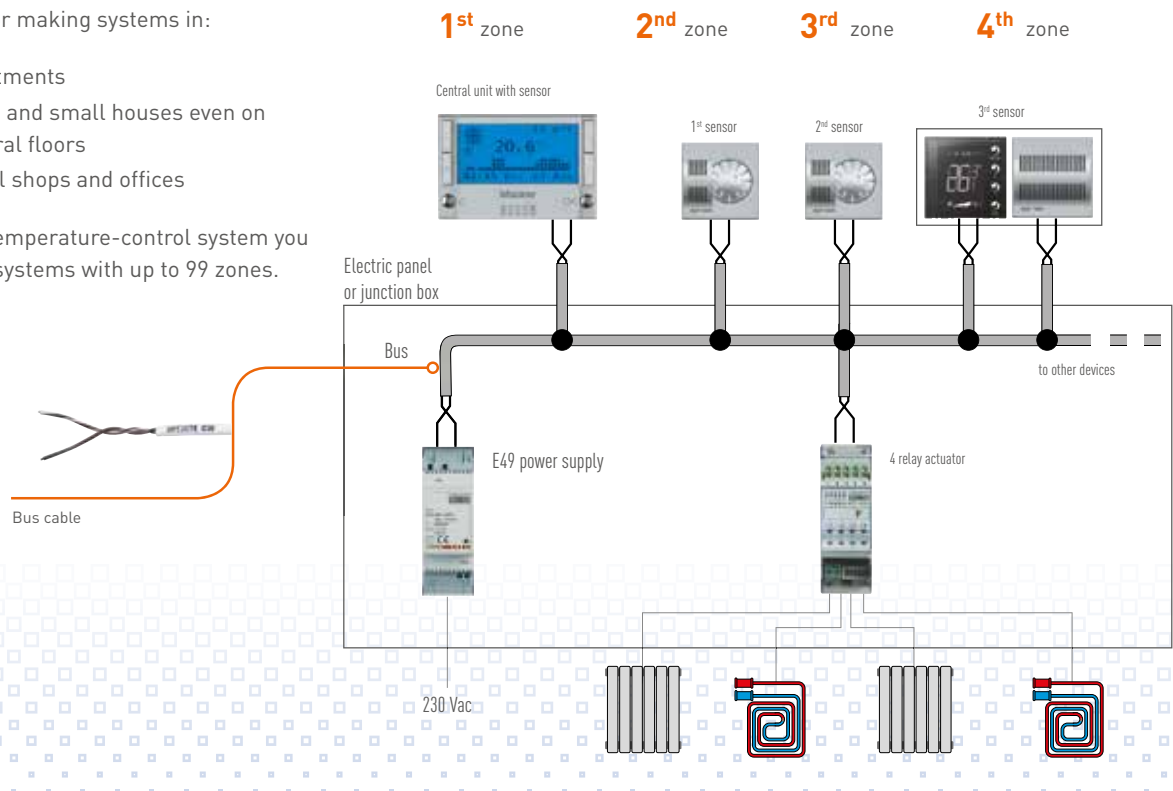

ADVANTAGES/BENEFITS

With zone temperature-control the heating or cooling is active in the whole house and the temperatures are adjusted on the basis of real needs and the solar irradiation.

- **Cost saving**
by installing multi-zone systems you can obtain cost savings of up to 30% with respect to traditional systems with a single thermostat.
- **Heat and cool exactly**
where and when needed avoiding waste and making maximum use of the sun's natural contribution.
- **Differentiate**
the temperature in relation to the room (bedroom, living room, office) and thus obtain "ideal" comfort on the basis of your needs and at the times you want.
- **Improve**
the energy classification of the buildings.
- **Safeguard**
the room, thanks to the reduction of CO₂ emissions in the air.

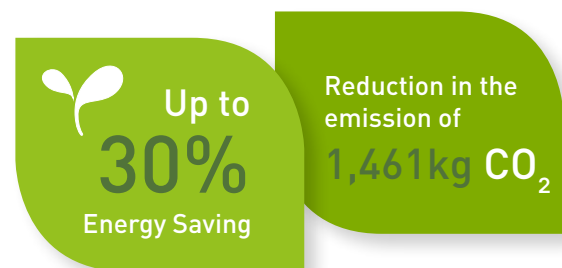

Calculation made on a 100 sq.m. home.
Italian conversion factor used: 0.406 kg CO₂ / kWh.
Calculation performed on an annual basis

→ Service sector

Management of the cold and/or hot temperature in offices

NEED

Making a temperature-control system (heating and cooling) which allows me to manage and adjust temperatures in different offices or areas of the complex independently.

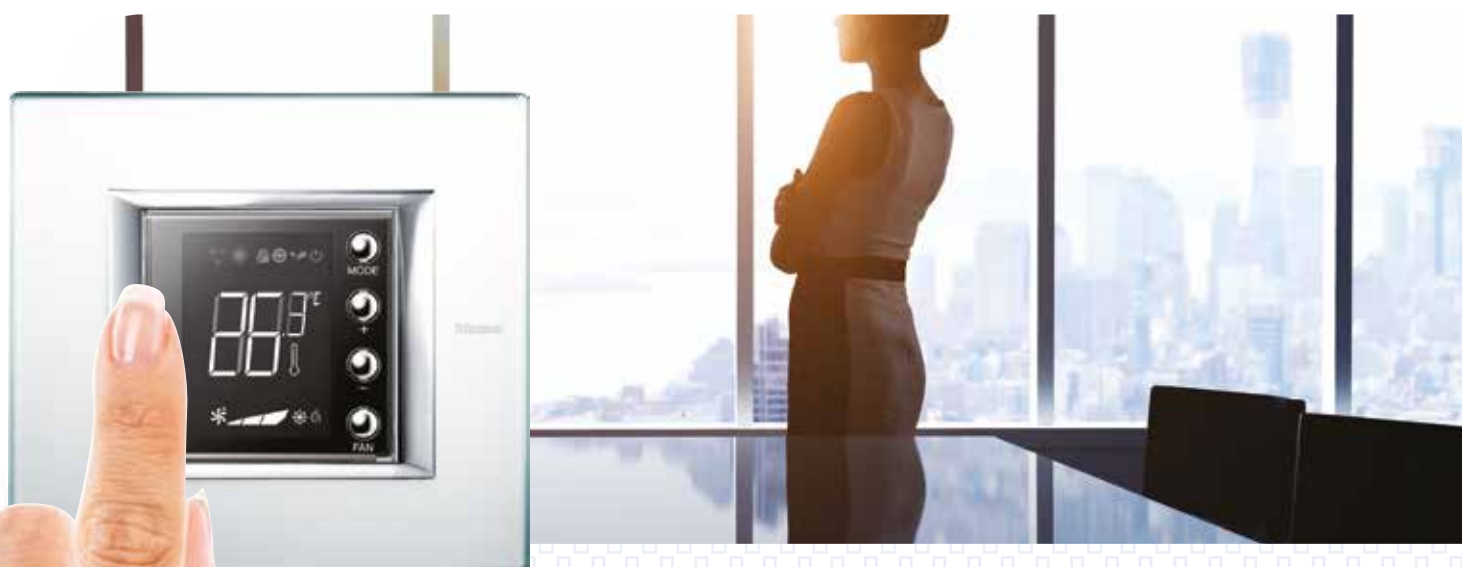

SOLUTION/PROJECT

Thanks to the "Zone temperature-control" system and dividing the building into separately-controlled zones you can: manage the comfort temperature only when people are present and manage the artificial heating or cooling only when it is really necessary, depending on the contribution of solar irradiation.

For example, in the cold season offices exposed to solar irradiation require less energy for heating than those not exposed to the sun.

System with central unit up to 99 zones

The 99-zone central unit is the ideal solution for making systems in:

- in residential contexts in large houses, apartment buildings and large buildings
- in the service sector in offices, shops, shopping centres and large banks

The 99-zone central unit can be controlled and managed remotely via Internet by means of the BTicino My Home Web portal.

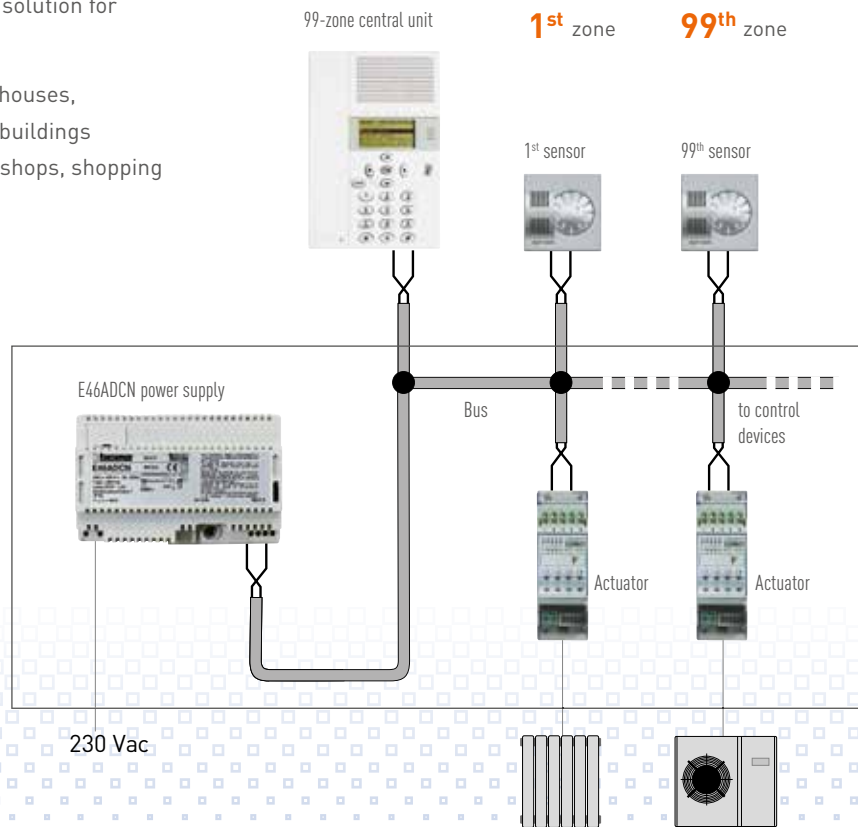

ADVANTAGES/BENEFITS

With zone temperature-control the heating or cooling is active in the whole building and the temperatures are adjusted on the basis of real needs and the solar irradiation.

- **Cost saving**
by installing multi-zone systems you can obtain cost savings of up to 30% with respect to traditional systems with a single thermostat.
- **Heat and cool exactly**
where and when needed avoiding waste and making maximum use of the sun's natural contribution.
- **Differentiate**
the temperature in relation to the room (bedroom, living room, office) and thus obtain "ideal" comfort on the basis of your needs and at the times you want.
- **Improve**
the energy classification of the buildings.
- **Safeguard**
the room, thanks to the reduction of CO₂ emissions in the air.



Calculation performed on a 3,000 sq.m. building for office use.

Italian conversion factor used: 0.406 kg CO₂ / kWh.
Calculation performed on an annual basis

→ Service sector

Typical hotel guest room in KNX solution

NEED

In a hotel room there is the need to manage everything when the customer is present: lighting, sockets, HVAC.

When the customer enters the room the entrance lights are automatically turned ON and when he puts the badge in the holder the HVAC and the sockets are also enabled. The customer is able to manage everything through the different central units, choosing the conditions he prefers according to his mood or needs.

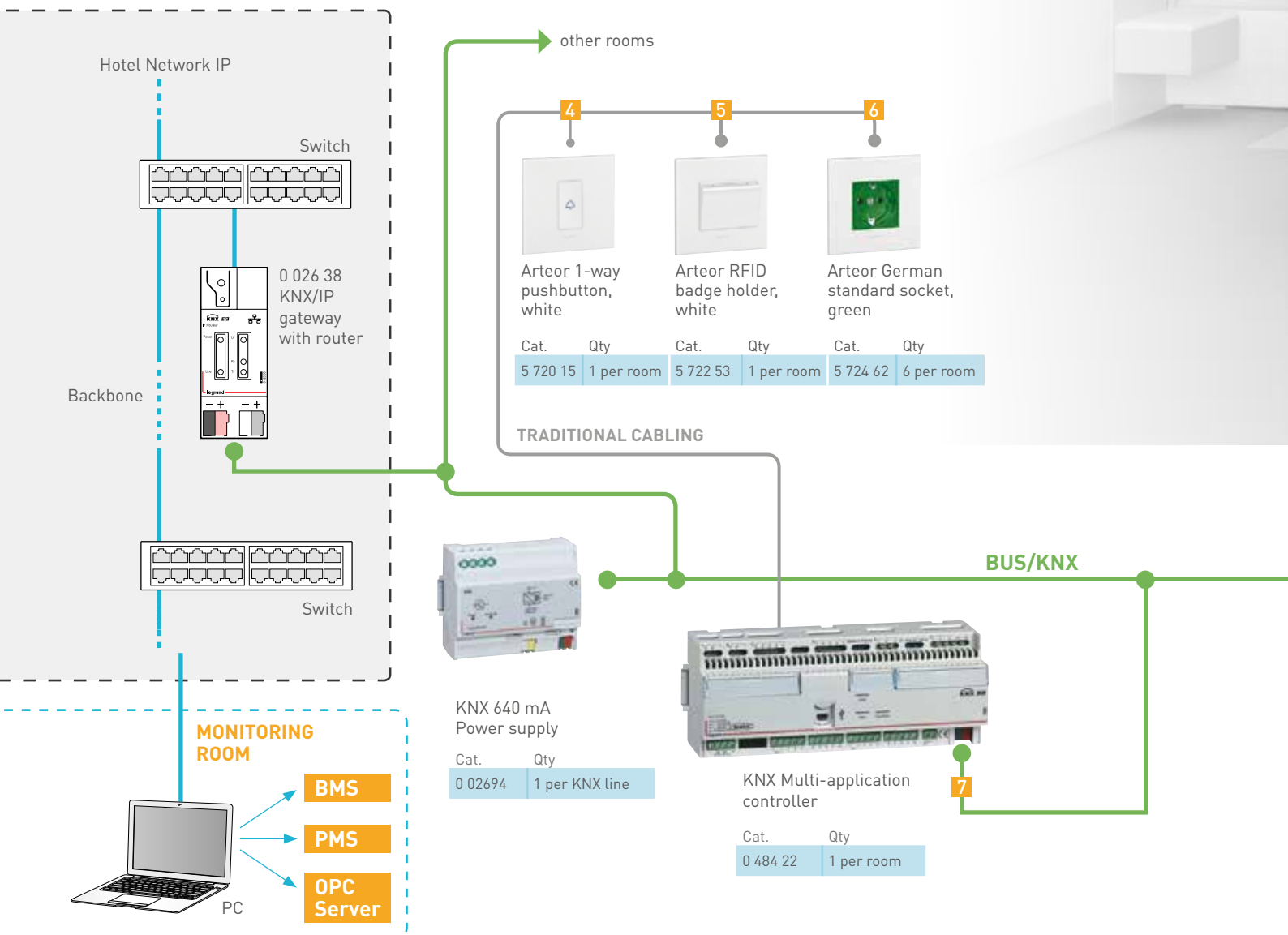

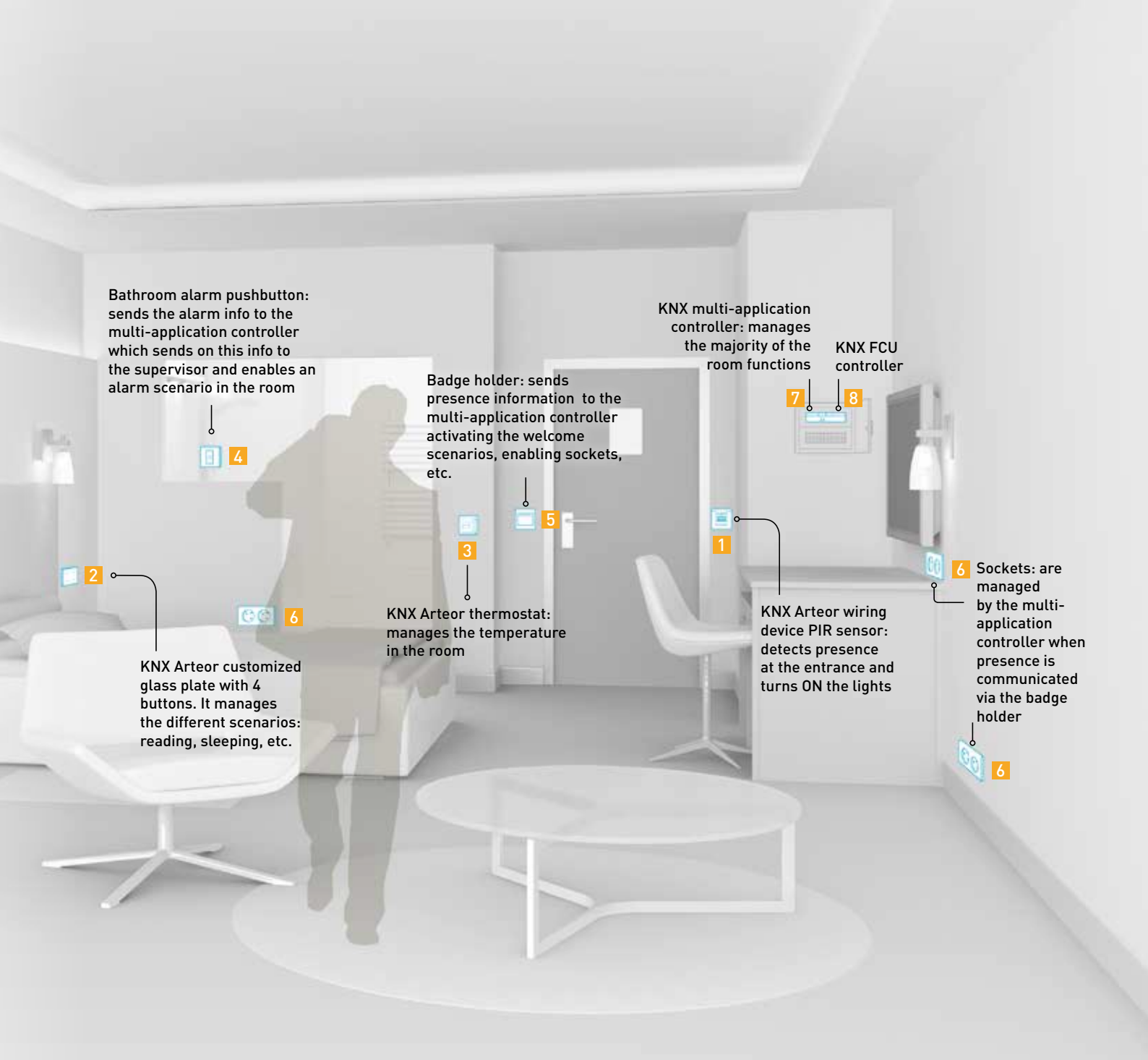

Bathroom alarm pushbutton: sends the alarm info to the multi-application controller which sends on this info to the supervisor and enables an alarm scenario in the room

Badge holder: sends presence information to the multi-application controller activating the welcome scenarios, enabling sockets, etc.

KNX multi-application controller: manages the majority of the room functions

KNX FCU controller

KNX Arteor customized glass plate with 4 buttons. It manages the different scenarios: reading, sleeping, etc.

KNX Arteor thermostat: manages the temperature in the room

KNX Arteor wiring device PIR sensor: detects presence at the entrance and turns ON the lights

Sockets: are managed by the multi-application controller when presence is communicated via the badge holder

1		2		3		8		other KNX devices in the room
								
KNX Arteor PIR wiring device sensor		KNX Arteor 4-pushbutton glass plate, white		KNX Arteor temperature control panel		KNX FCU controller		
Cat.	Qty	Cat.	Qty	Cat.	Qty	Cat.	Qty	
5 740 37	1 per room	5 735 04	2 per room	0 674 64	1 per room	0 026 97*	1 per room	

*depending on the type of fan coil unit

Wiring diagram of a typical hotel room - single phase (230 Va.c.)

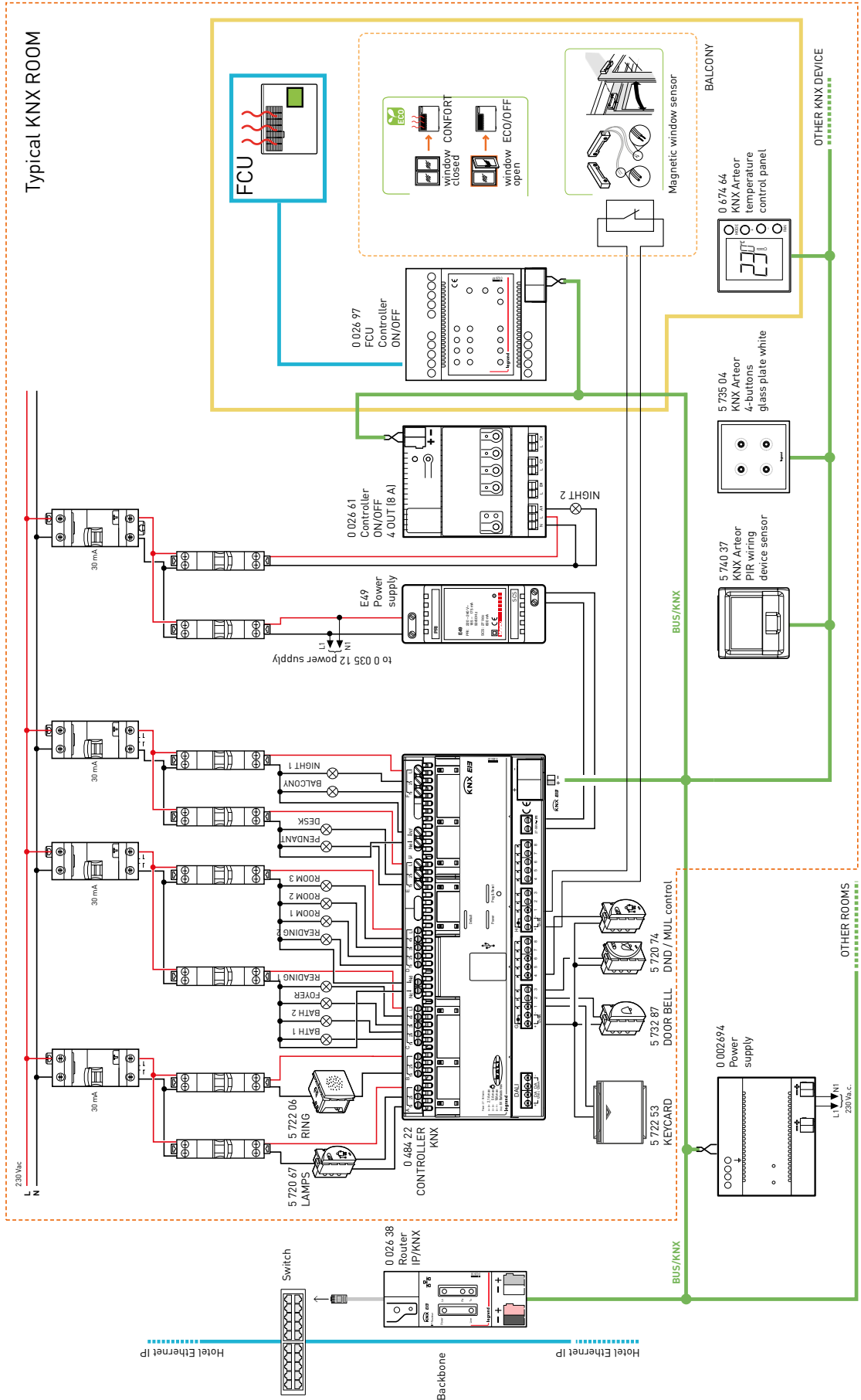



ADVANTAGES/BENEFITS

With zone temperature-control the heating or cooling is active in the whole building and the temperatures are adjusted on the basis of real needs and the solar irradiation.

- **Cost saving**
by installing multi-zone systems you can obtain cost savings of up to 30% with respect to traditional systems with a single thermostat.
- **Heat and cool exactly**
where and when needed avoiding waste and making maximum use of the sun's natural contribution.
- **ECO function**
The ECO function allows you to switch the heating or cooling off when a window is open.
- **Improve**
the energy classification of the buildings.
- **Safeguard**
the room, thanks to the reduction of CO₂ emissions in the air.

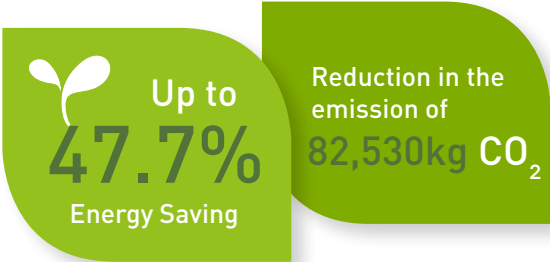

Calculation performed for an 80-room hotel.
Italian conversion factor used: 0.406 kg CO₂ / kWh.
Calculation performed on an annual basis

→ Service sector

Toilet facilities management of lighting and ventilation

NEED

- Automatically switching the lighting and ventilation on and off on the basis of the detection of movement.

Type of lighting

- T5 linear fluorescent lamps

Room description

- Use of the Toilet space
- Sizes: 20 m² separate area
3 m² each toilet
- Ceiling height: 2.50 m
- Windows: none

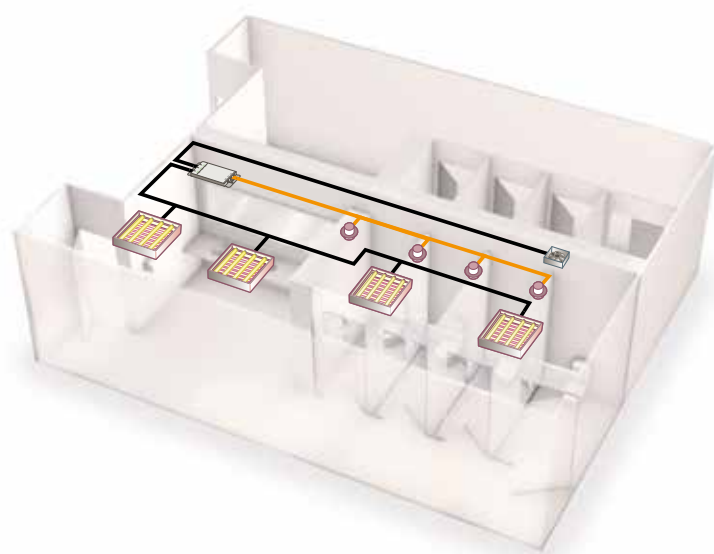

SOLUTION/PROJECT

- Passive infrared ceiling mounted SCS sensor
- Room Controller Stand Alone ON-OFF

Install an SCS passive infrared ceiling SCS sensor item 0 488 20 in each bathroom:
the sensors switch the lighting and ventilation on when the toilet is occupied and switch everything off when no movement is detected.

All the sensors are connected to the Stand Alone ON-OFF room controller item 0 488 50 installed in the false ceiling

INSTALLATION NOTES

1. Install the Stand Alone ON-OFF room controller item 0 488 50 on the cable tray in the false ceiling.
2. Install SCS passive infrared ceiling SCS sensors item 0 488 20 in each bathroom:
3. The sensor has the following factory settings: delay time 15 minutes, brightness threshold 500 lux, maximum PIR sensitivity.
Whenever necessary use the configuration remote control item 0 082 30 to change the sensor parameters.

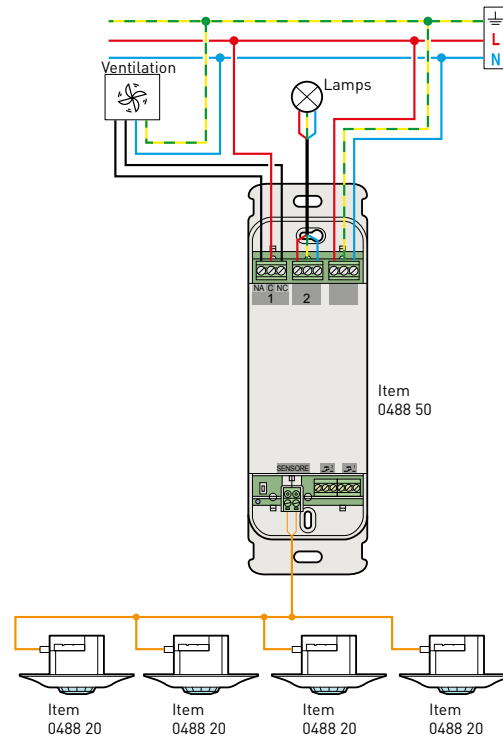

List of materials

ITEM	QUANTITY	DESCRIPTION
0 488 20	1	PIR ceiling mounted SCS sensor
0 488 50	1	Room Controller Stand Alone ON-OFF



ADVANTAGES/BENEFITS

Automatically switch the lighting and ventilation on and off only when people are present.

- **Cost saving**
by installing technological systems or products you can obtain cost savings with respect to the use of traditional systems or products.
- **Safeguard**
the room, thanks to the reduction of CO₂ emissions in the air.

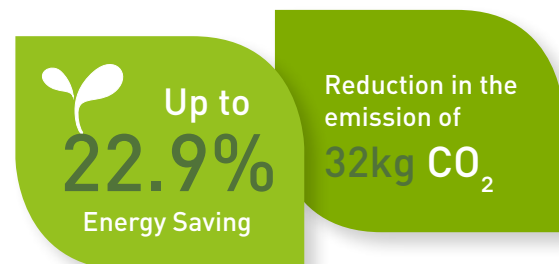

Calculation performed on 20 sq.m. toilet facilities.
Italian conversion factor used: 0.406 kg CO₂ / kWh.
Calculation performed on an annual basis

→ Service sector

Single workstation with automatic lighting management

NEED

- Manual switching on of the lighting and automatic switching off on the basis of presence detection
- ON-OFF management
- Presence detection

Type of lighting

- T5 linear fluorescent lamps

Application description

Use of the office Activity space such as reading, writing, working at the computer, etc..

Sizes: (2.50 x 2.50 m) x 4

Ceiling height: 2.50 m



SOLUTION/PROJECT

Double technology flush-mounting sensor in domestic series.

The main lighting is supplied by the ceiling lamps.

In this case, the desk lamps are controlled by the double technology flush-mounting sensor in domestic series item L4433N placed in the column at the side of the workstation and are lit manually by means of the pushbutton on the sensor. When the desk is not occupied the lights go out automatically at the end of the delay time set on the sensor.

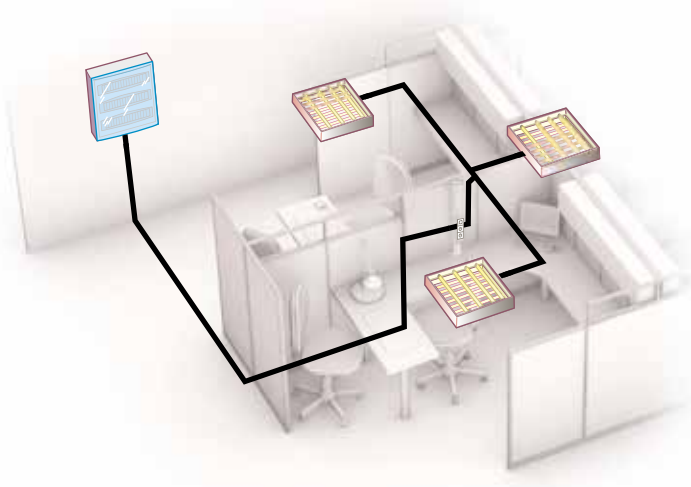

INSTALLATION NOTES

1. Install the flush-mounting double technology sensor in domestic series item L4433N in the column at the front of the desk to ensure optimum detection.
2. The sensor has the following factory settings: delay time 15 minutes, brightness threshold 300 lux, maximum PIR sensitivity and high US. Whenever necessary use the configuration remote control item 0 082 30 to change the sensor parameters.

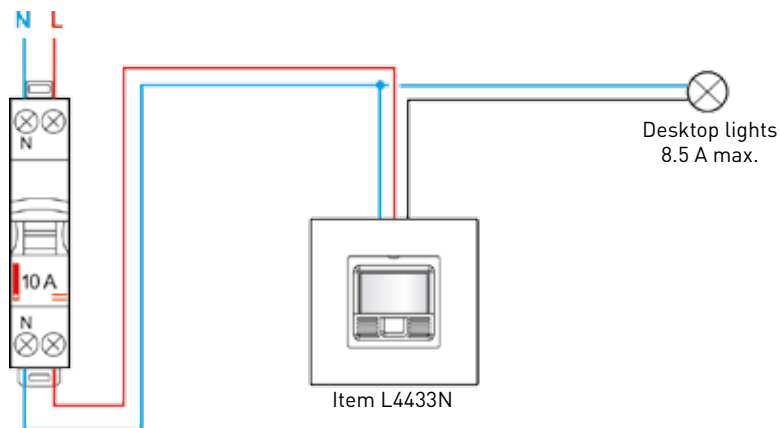

List of materials

ITEM	QUANTITY	DESCRIPTION
L4433N	1	LivingLight - Green Switch PIR+US anthracite



ADVANTAGES/BENEFITS

Thanks to the manual switching on of the light and the automatic switching off on the basis of presence detection we obtain comfort and energy and cost saving.

- Cost saving**
 by installing technological systems or products you can obtain cost savings with respect to the use of traditional systems or products.
- Safeguard**
 the room, thanks to the reduction of CO₂ emissions in the air.

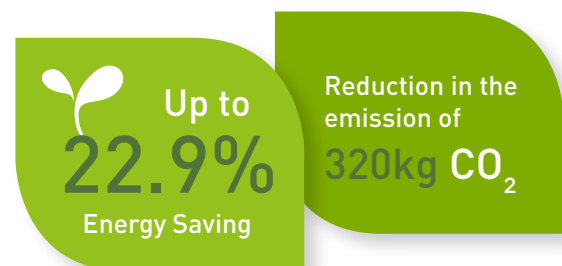

Calculation performed on a 200 sq.m. open plan office
 Italian conversion factor used: 0.406 kg CO₂ / kWh.
 Calculation performed on an annual basis

→ Service sector

School room with management of light and change of air

NEED

- Manual switching on of the lighting and automatic switching off on the basis of presence detection and the contribution of natural light.
- Automatic management of an HVAC device on the basis of presence detection.
- Dimmer management
- Presence detection
- Presence of natural light
- Ventilation system management

Type of lighting

- T5 linear fluorescent lamps with DALI ballast

Room description

Use of the teaching activity space such as training, meetings, etc..

Sizes: 40 m²

Ceiling height: 2.50-3 m

Windows along the wall



SOLUTION/PROJECT

- Room Controller Stand Alone Dimmer Dali
- Double technology ceiling flush mounted sensor
- Traditional electromechanical pushbutton.

The Room Controller item 0 488 51 will control two groups of lamps (one A defined master and one B defined slave) maintaining a defined brightness difference between A and B. The double technology sensor item 0 488 22 will adjust the lighting level on the basis of the brightness level and presence and will also control the activation of the HVAC device, but only on the basis of presence. The pushbuttons item L4005N allow the manual switching on and adjustment of two groups of lamps.

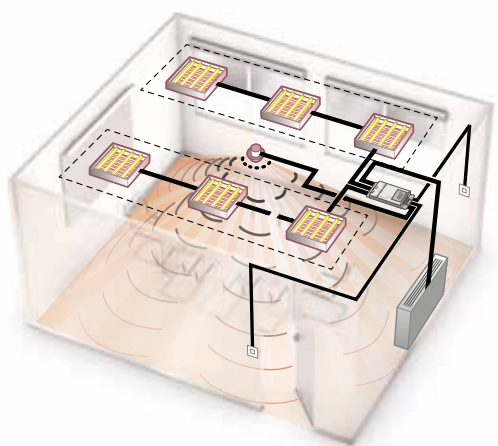

INSTALLATION NOTES

1. Install the Room Controller item 0 488 51 at the centre of the room in the false ceiling.
2. Install the SCS double technology sensor item 0 488 22 at the centre of the room so as to ensure an optimum detection of presence and brightness level. It can be installed flush mounted by means of springs or flush-mounting box for concrete ceilings item 89358 or plasterboard ceilings item PB502. As an alternative it can be installed on the ceiling surface by means of accessory item 048875.
3. Install the item L4005N pushbuttons at the room entrance.
4. Connect the Room Controller to the power supply (230 V a.c.), the sensor (by means of bus cable item L4669HF at the RJ45 input), the controls (terminals DA1 and DA2) and the fans (NO/C/NC output).
5. Configure the Room Controller by selecting mode 1, 2 or 3 as required, by means of the selection pushbutton.
6. The sensor has the following factory settings: delay time 15 minutes, brightness threshold 500 lux, very high PIR sensitivity and high US sensitivity. Whenever necessary use the configuration remote control item 0 082 30 to change the sensor parameters.

PLUG & GO configuration mode

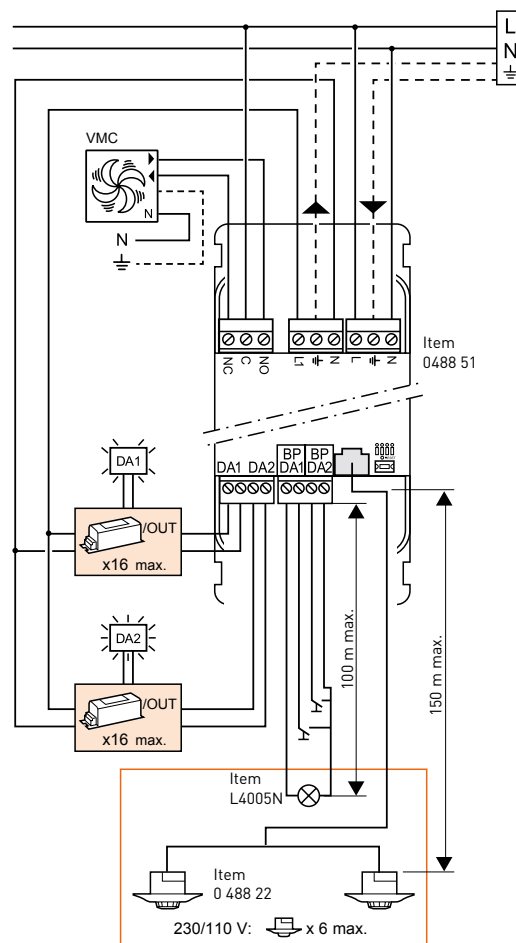

List of materials

ITEM	QUANTITY	DESCRIPTION
0 488 51	1	1-10V 4x4.3A SCS Room Controller
0 488 22	1	PIR+US IP20 ceiling mounted SCS sensor
L4005N	2	LL - 1P NO 10A 1m anthracite pushbutton
L4669HF	1	SCS BUS cable



ADVANTAGES/BENEFITS

- **Cost saving**
by installing technological systems or products you can obtain cost savings with respect to the use of traditional systems or products.
- **Safeguard**
the room, thanks to the reduction of CO₂ emissions in the air.

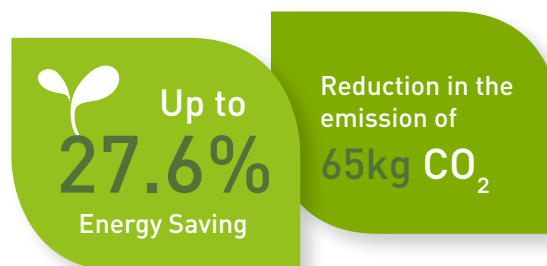

Calculation performed on a 40 sq.m. school room.
Italian conversion factor used: 0.406 kg CO₂ / kWh.
Calculation performed on an annual basis

→ Service sector

Large meeting room: lighting management

NEED

- Manual switching on of the lighting and automatic adjustment on the basis of presence detection and the contribution of natural light.
- ON-OFF management and dimmer 1-10 V management
- Presence detection
- Presence of natural light

Type of lighting

- T5 linear fluorescent lamps with 1-10V ballast
- Halogen lamps interfaced with 1-10V ballast

Room description

Use of the Meeting room, presentations

Sizes: 50 m²

Ceiling height: 2.50 m

Windows: along one wall with view of the outside (e.g. design team)



SOLUTION/PROJECT

- SCS double technology ceiling sensor
- Room Controller SCS for 1-10 V ballast
- 2-module SCS control

The SCS two-module control item L4652/2 is used to manually switch on/off and adjust the light intensity of the lamps above the table (+ circuits).

The SCS double technology ceiling sensor item 0 488 22, configured in ECO mode, is installed at the centre of the meeting room so as to ensure optimum detection. This sensor switches off all the lights when no presence is detected and adjusts the intensity of the lamps above the table (+ circuits) on the basis of presence detection and the contribution of natural light.

The second SCS two-module control item L4652/2 manages the lighting of the screen and the blackboard (+ circuits). The SCS 1 – 10 V room controller item BMDI3002 is fastened on the cable tray in the false ceiling.

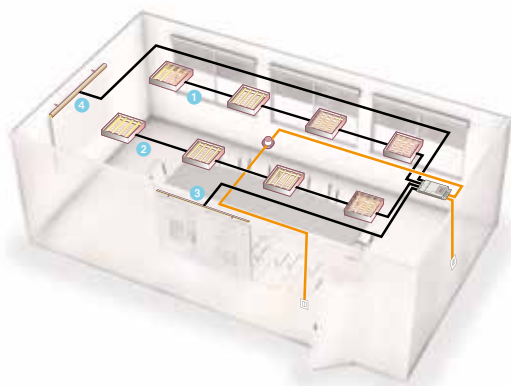

INSTALLATION NOTES

1. Install the SCS sensor item 0 488 22 at the centre of the room to ensure optimum detection. Install the SCS controls item L4652/2 at the room entrance and install the room controller item 0 488 22 in the false ceiling.
2. Connect the sensor and the control to input 3 of the room controller. The sensor, control and room controller can be connected by means of SCS cable item L4669, L4669/500, L4669HF or RJ45 patch cord. Connect the SCS control to input 4 of the room controller. The control and room controller can be connected by means of SCS cable.
3. Configure the sensor connected to input 3 by means of the Push & Learn procedure so that it controls the central lamps (+ circuit) and the SCS control pushbuttons connected to the same input so that each one controls one of the two circuits. Configure the second SCS control connected to input 4 so that the first pushbutton controls the screen lamps (circuit) and the second the blackboard lamps (circuit). Consult the Push & Learn procedure manual which can be downloaded from the www.legrandoc.com site for more detail.
4. The sensor has the following factory settings: delay time 15 minutes, brightness threshold 500 lux, maximum PIR sensitivity. Whenever necessary use the configuration remote control item 0 082 30 to change the sensor parameters.

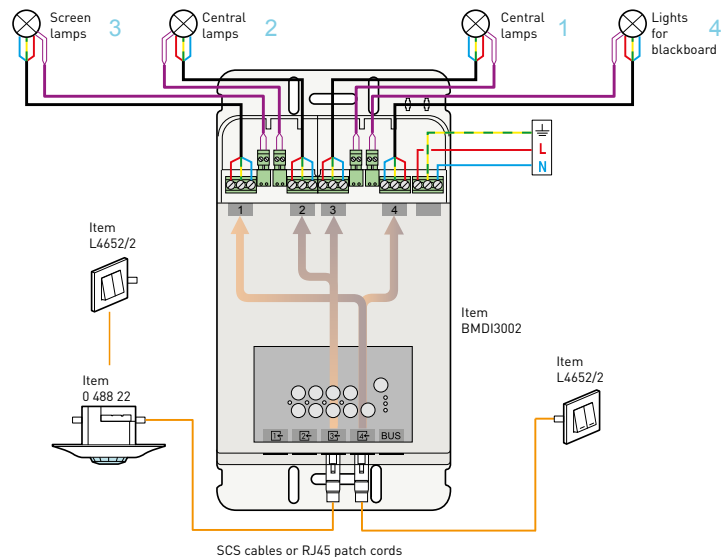

List of materials

ITEM	QUANTITY	DESCRIPTION
BMDI3002	1	Room Controller SCS 1-10 V 2x4.3A
0 488 22	1	PIR+US ceiling mounted SCS sensor
L4652/2	2	SCS - 2 mod single/double load control

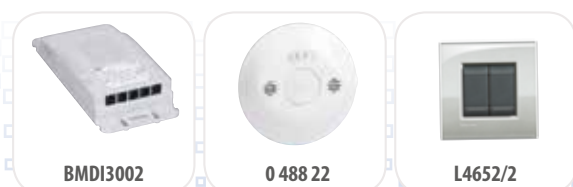

ADVANTAGES/BENEFITS

- **Cost saving**
by installing technological systems or products you can obtain cost savings with respect to the use of traditional systems or products.
- **Safeguard**
the room, thanks to the reduction of CO₂ emissions in the air.

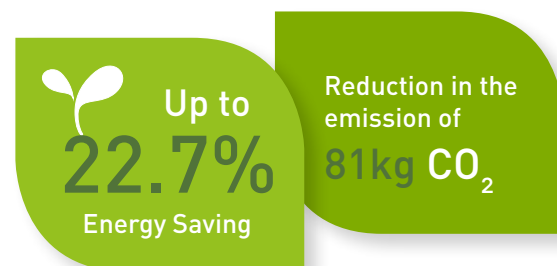

Calculation performed for a 50 sq.m. meeting room.
Italian conversion factor used: 0.406 kg CO₂ / kWh.
Calculation performed on an annual basis



8

Reference projects

- Residential sector
- Service sector
- Industry

→ Residential sector

Residential area “Le Albere” (Trento - Italy)

The most important city revitalisation project ever carried out in Trentino.

Two attractions: the Polo Sud and the Science Museum (MUSE).

Residences, businesses, recreational spaces and offices occupy the rest of the area.

Conceived and designed by the architect Renzo Piano and, for the technological part, by the Manens TIFS studio of Verona. My Home has been used in the residential area for home automation, video door entry and management of the residential complex.



PRODUCT INSTALLATION

- EDM transformers
- Zucchini busbars, light and power
- My Home Automation System

→ Service sector

Banco di Sardegna (Sassari - Italy)

The Banco di Sardegna has used a remote control and management system developed with BTicino to reduce the electrical power consumptions of its branches.

At present 200 branches are managed with a return on investment (ROI) of less than 2 years.



SUPERVISION SYSTEM



- Metering
- Automation
- Lighting control
- Email reporting
- Email alarms
- Geolocation

PRODUCT INSTALLATION



Power



Metering



myHOME

→ Service sector

Marshalls and Brigadeers School (Florence - Italy)

The new “Marshalls and Brigadeers School” of the Florence Carabinieri, commissioned by the Ministry of Infrastructure for the Arma of the Carabinieri, has been designed as a small self-sufficient town, over an area of about 30,000 sq.m., organized around the needs of the students and the structure operators.



SUPERVISION SYSTEM



- Metering
- Automation
- Lighting control
- SMS alarms

INTEROPERABILITY



PRODUCT INSTALLATION

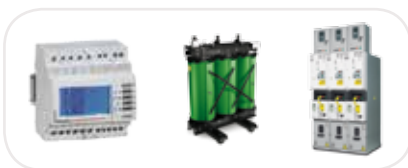

Power



Metering



myHOME



UPS

→ Service sector

Data Center in University centre (Wageningen - NL)

Wageningen University with an annexed Research Institute is a public university of the Netherlands, which specialises in agrarian studies.

The Wageningen University centre is made up of:

- 6,500 employees
- 10,000 students
- IT department with 170 employees



PRODUCT INSTALLATION

Construction of a new 120 sq.m. DC complete with:

- Cold corridors
- Racks 19 inches
- Intelligent PDU which can supply precise information on the instantaneous use of energy by the equipment.
- Solution to manage and monitor the power used in the system (Varicontrol C)
- Accessories for wiring management

SUCCESS CONDITIONS

- Markedly modular solutions proposed by Minkels which can adapt to the special features of the environment.
- Flexibility of the Minkels response to the needs of the unusual location of the system.
- Capacity to customize the products to answer the special needs of the system.

→ Service sector

Socom BNP Paribas (Paris - France)

Park of electric vehicles



SUPERVISION SYSTEM



- Metering
- Automation
- EV charging station

PRODUCT INSTALLATION



Power



Metering



Green'Up

→ Service sector

Hospital Regional (Rancagua - Chile)

Designed with a high level of technological innovation for energy efficiency of the highest standards for hospitals. System made for an area of 90,000 m² on 6 floors and 550 patient beds.



INSTALLED PRODUCTS

- Transformers with 2000 kVA, 1600 kVA and 800 kVA power
- DPX 1600, 630, 400, 250, 125 protections
- EDMX electrical measurements
- 600 kVAr and 480 kVAr capacitor banks
- Watt Stopper Stand Alone presence sensors
- Keor and Daker UPS

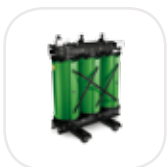

Green
Trasformer



UPS



Capacitor
banks



Watt Stopper
sensors

→ Service sector

Descartes

a BEPOS university (Champs sur Marne - France)

This 5,000 sq.m. building, on 5 floors, aims to reduce its energy footprint to zero. The aim is to build a BEPOS +32% building, as well as to obtain the HQE mark and BBC 2005 certification.



CLIENT

ECOLE NATIONALE DES PONTS ET CHAUSSEES

- Type of project: New Building
- Type of building: School, college, high school or university
- Construction site: Champs sur Marne (77)
- Year of delivery: 2013
- Net surface: 5 178 m² SHON
- Construction cost: 12 500 000 €

→ Service sector

School department

Julie-Victoire Daubié

(Lyon - France)

The school has 16 classes with gymnasium, canteen, medical and social centre, housing for the caretaker and various activity rooms with an overall area of 3445 m²; the energy aim is to reach the BEPOS level.



CLIENT

CITY OF LYON

- Type of project: New Building
- Type of building: School department
- Construction site: Lyon (69)
- Year of delivery: 2013
- Net surface: 3 445 m² SHON

→ Service sector

Al Habtoor City

Hotel and Resort (Dubai - United Arab Emirates)

A total of 1608 rooms of Starwoods Hotels and Resort (1004 rooms Westin Hotel + 370 rooms W Hotel + 234 rooms St Regis Hotel) equipped in Arteor Guest Room Management System



PRODUCT INSTALLATION

- BacNet Guest room management system
- VDI Structured Cabling
- Switchgear
- Wiring Devices
- Trunking
- Floor Box

BUILDING SPECS

- Operator: STARWOOD
- Consultant: KHATIB & ALAMI, MDG
- Contractor: HABTOOR SPEC CON
- Completion: (2015 St. Regis) & (2016 W and Western)
- Project Value: \$ 912M

→ Service sector

Novartis offices with KNX (Madrid - Spain)

Single building developed over 5 floors year 2016, sold by Legrand Spain



PRODUCT INSTALLATION

- Manual controls
- Sensors
- Touch screen (3rd party)
- Supervision (3rd party)
- v1-10V controllers (3rd party)

SUCCESS CONDITIONS

Project solution has been presented, designed by S.I partner in Madrid. He explained the customer how KNX can be mixed and merged between different manufacturer and achieved to get the business. Commissioning will be made by him too.

→ Service sector

Wellness Resort Marina Verde (Venice - Italy)

This is a tourist and residential complex in a seaside resort with 73 high-level housing units of various sizes, some with roof gardens and private pools, a reception, a bar/restaurant, a congress hall, 2,500 sq.m. solarium zone with heated pools, as well as 2,000 sq.m. of wellness centre.



PRODUCT INSTALLATION

- My Home zone temperature control
- My Home Automation
- Axolute civil series

→ Service sector

Carlo Mollino Refuge (Aosta - Italy)

The Carlo Mollino refuge, built at an altitude of more than 2,000 metres, is equipped with the best efficiency control solutions to prevent even the smallest energy wastage.



PRODUCT INSTALLATION

- Civil series: Livinglight
- Zone temperature control system
- Home automation system: MyHome

→ Service sector

Co.Mark at Kilometro Rosso Consulting Company (Bergamo - Italy)

Temporary Management Consulting Company. Installation of a Lighting Management system in the offices inside the Technological Park of Kilometro Rosso, Stezzano (BG). A Lighting Management system with centralized bus and rolling shutter automation with remote control



PRODUCT INSTALLATION

- EDM cast resin transformer
- SCP Zucchini busbars
- Lighting Management - Switch Sensor

→ Industry

BTICINO sites supervision (Italy)

Supervision and control via WEB of the significant energy consumptions of the sites in Italy (Energy Management System, certificate ISO50001).



LEGRAND TURNOVER

	k€	mWh (eq)	CO2 (tons)
last 3yr	170	1500	1750
2017 (obj)	200	1900	2500

SITES

- Varese
- Erba
- Tradate
- Bergamo
- Muscoline
- Alessandria
- Ospedaletto
- Teramo
- Torre del Greco

MEASURES

- Electricity
- Gas
- Water

Energy saving
ISO 50001



→ Industry

GAS station with KNX (Dunkerque - France)

Six building developed over 3 floors each, year 2014 - 2015



PRODUCT INSTALLATION

- Installed about 260 products
- Switching actuators
- DALI gateway
- Manual controls
- Input interfaces

SUCCESS CONDITIONS

The project has been entirely managed by Italy big projects team.

The solution has been negotiated with other parties (Sauter) who provided other systems.

Programming has been made by Italy S.I. partner.

→ Industry

Mirafiori Factory

FCA - Fiat Chrysler Automobiles (Turin - Italy)

BTicino cools the FCA motors. BTicino has supplied the transformer station which, in the Mirafiori plant, guarantees optimum operating conditions for the cells where the motors of some of the new Group models are tested.



PRODUCT INSTALLATION

- 2 Green T.HE transformers with 1600 kVA BT/BT
- Zucchini SCP busbars with 2000 A
- Legrand Daker Ups for cabin services

→ Industry

Sigit Factory

(Kragujevac - Serbia)

Supplying company of an Italian car company with production site in Serbia.

Producer of 70% of the plastic components of a new model of car.



PRODUCT INSTALLATION

- EDM cast resin transformer
- SCP Zucchini busbars
- Lighting Management Switch Sensor

→ Industry

Minkels data center

Swiss mountains (San Gottardo - Swiss)

The Deltalis TIER 4 Data Center is located in the depths of a mountain near the Saint Gotthard massif in Switzerland. The Data Center is located inside the mountain in an area previously used as a military base with 15,000 sq.m. of occupied surface. This Data Center has direct access to the main Internet interconnectors which cross Switzerland from north to south.



PRODUCT INSTALLATION

- Cold corridors to obtain separation between flows of cold and hot air and make the whole system more efficient
- 19" server racks
- Innovative and efficient cooling system which uses the mountain's natural resources, such as the water from a glacier

SUCCESS CONDITIONS

- Markedly modular solutions proposed by Minkels which can adapt to the special features of the environment
- Flexibility of the Minkels response to the needs of the unusual location of the system
- Capacity to customize the products to answer the special needs of the system

Note



FOLLOW US

@ website: www.legrand.com

 www.youtube.com/legrand

 www.twitter.com/legrand



Head office
and International Department
87045 Limoges Cedex - France
Tel. + 33 (0) 5 55 06 87 87
Fax + 33 (0) 5 55 06 74 55